

Shandon Cytospin 4

Operator Guide - English

A78310250

Issue 4

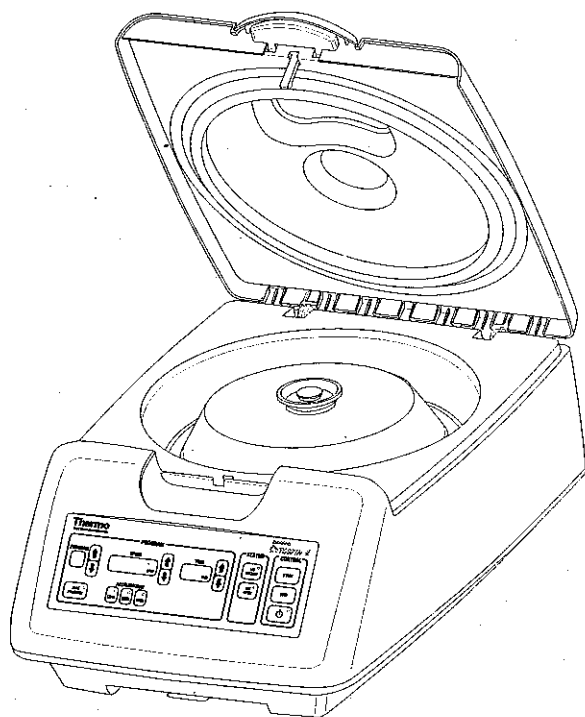

© 2004 Thermo Electron Corporation. All rights reserved.

Thermo Shandon Limited is an ISO 9001 and TickIT Accredited Company
Thermo Electron Corporation is the trading name of Thermo Shandon Limited

Clorox® is the trademark of Clorox Company;

Decon® is the trademark of Decon Laboratories Limited;

CytoRich® is the trademark of TriPath Imaging Inc;

Carbowax® is the trademark of Union Carbide Corporation;

Ficoll® is the trademark of Amersham Biosciences;

Hypaque® is the trademark of Stirling Drug

All other trademarks are the property of Thermo Electron Corporation and its subsidiaries

Thermo Electron Corporation makes every endeavour to ensure that the information contained in its support documentation is correct and clearly stated but does not accept responsibility for any errors or omissions. The development of Thermo products and services is continuous. Make sure that any published information that you use for reference is up to date and relates to the status of the product. If necessary, check with Thermo or your local Thermo representative.

This manual may not, in whole or in part, be copied, photocopied, reproduced, translated, or converted to any electronic or machine readable form without prior written consent of Thermo.

All information contained in this manual is proprietary and confidential, and the exclusive property of Thermo Electron Corporation. This manual is protected by copyright and any reproduction is prohibited. This manual is for use only by the individuals to whom it has been made available by Thermo Electron Corporation.

Contact Addresses

Clinical Diagnostics
Anatomical Pathology
93-96 Chadwick Road
Astmoor, Runcorn
Cheshire, WA7 1PR, UK
Tel: +44 (0) 1928 566611
Fax: +44 (0) 1928 565845
www.thermo.com/shandon

Clinical Diagnostics
Anatomical Pathology
171 Industry Drive
Pittsburgh
PA 15275, USA
Tel: 1-800-547-7429
+1 412 788 1133
Fax: +1 412 788 1138
www.thermo.com/shandon



The Shandon Cytospin 4 range meets the following CE Mark requirements:

In Vitro Diagnostic Directive 98/79/EC

Low Voltage Directive 73/23/EEC, as amended by 93/68/EEC.



Contents

1	Welcome	5
	Introduction; Safety	
2	Description	9
	Overview	
3	Installation And Setting Up	11
	Procedure; Unpacking; Setting Up the Instrument; Electrical Requirements; Accessories	
4	Controls	27
	Introduction; Main Control Panel;	
5	Operation	35
	Introduction; Operating the Cytospin	
6	Cleaning And Maintenance	51
7	Troubleshooting	63
	Introduction; Equipment Status Checks; Error Codes; Troubleshooting Results	
8	Specification And Accessories	75
9	Warranty Statement	81
	Warranty Statement; Declaration of Conformity	
Appendix A	Standard Workflow Diagram	85
Appendix B	Methodology Guidelines	87
Appendix C	Transportation Instructions	109
	Instructions; Product Return Safety Declaration	
Appendix D	Approved Reagent List	113
	Index	115

Symbols

The following symbols and conventions are used throughout this manual and on the instrument.



THIS SYMBOL IS USED ON THE EQUIPMENT, OR IN A DOCUMENT, TO WARN THAT INSTRUCTIONS MUST BE FOLLOWED FOR SAFE AND CORRECT OPERATION. IF THIS SYMBOL APPEARS ON THE INSTRUMENT, ALWAYS REFER TO THIS OPERATOR GUIDE. ▲



THIS SYMBOL IS USED ON THE EQUIPMENT, OR IN A DOCUMENT, TO WARN THAT THERE MAY BE A BIOHAZARD ASSOCIATED WITH THE INSTRUMENT. ALWAYS ACT WITH COMMON SENSE AND BE AWARE OF THE SAMPLES USED. TAKE SUITABLE PRECAUTIONS. ▲

WARNING

A warning is given in the document if there is a danger of personal injury or damage to samples or equipment. ▲

Note Notes give more information about a job or instruction but do not form part of the instruction. ▲

Chapter 1 Welcome

Welcome to the Thermo Electron Corporation Shandon Cytospin® 4 cytocentrifuge. Designed and made with care, the instrument is safe to use, simple to operate, and easy to maintain.

The Shandon Cytospin 4 is a self-contained cytocentrifuge whose primary function is to produce a monolayer of cells onto a glass slide from any fluid suspension under the safest conditions possible.

This Operator Guide gives instructions for the correct operation and use of the Shandon Cytospin 4.

Safety

Thermo products are designed for convenient and reliable operation and to accepted standards of safety. The use of the Shandon Cytospin 4 does not entail any hazard if operated in accordance with the instructions given in this manual. However, incorrect actions by a user may damage the equipment, or cause a hazard to health. It is important for you to obey the following safety precautions:



THIS PARAGRAPH DETAILS IMPORTANT SAFETY INFORMATION. PLEASE READ THIS SECTION CAREFULLY. ▲

- 1 All users must read and understand the Operator Guide and only operate the unit in accordance with the instructions. If the instructions are not followed, then the protection provided by the instrument may be impaired.

- 2 The Shandon Cytospin 4, as supplied, conforms with IEC1010-2-020.
- 3 Potentially lethal voltages above 110V a.c. or 50V d.c. are present inside the instrument. Do not remove any access covers unless specifically instructed to do so.
- 4 This instrument must be properly connected to a good earth (Ground) via the mains input supply.
- 5 Do not remove any panels or covers. The Shandon Cytospin 4 does not have any user serviceable parts inside the instrument.
- 6 The Shandon Cytospin 4 weighs approximately 12 kilograms (26.5 lbs); if necessary, get help to move or lift it.
- 7 Shandon Cytospin 4 is not intended for use with flammable materials or solvents, nor with materials which could be explosive or chemically reactive.
- 8 Always load and unload the sealed head in a biologically safe fume cupboard. Assume that the samples are biologically hazardous.
- 9 Bioseals and other biosafety components cannot be relied upon as a sole safeguard against contamination by pathogenic micro-organisms.
- 10 It is important that normal standards of safety and good laboratory practices are employed. Always use common sense and the best known practice when operating the instrument.
- 11 Refer to your own laboratory procedures and manufacturer's data sheets when using reagents.
- 12 Any problems and queries should be referred to your Thermo supplier.

- 13 Correct maintenance procedures are essential for consistent performance. It is recommended that a Maintenance Contract is taken out with the Thermo Service Department.
- 14 The instrument must be serviced by a Thermo trained engineer in accordance with the instructions contained in the Shandon Cytospin 4 Service manual (A78310251).
- 15 If the instrument has been used with materials that are toxic or contaminated with pathogenic microorganisms, follow the cleaning instructions given in Chapter 5. The Product Return Certificate (*see Appendix C*) must be filled in if the instrument is to be returned to Thermo.
- 16 Use only factory approved accessories or replacement parts with the Shandon Cytospin 4.

Welcome

Chapter 2 Description

Overview

The different components of the Shandon Cytospin 4 centrifuge are shown in the diagram below.

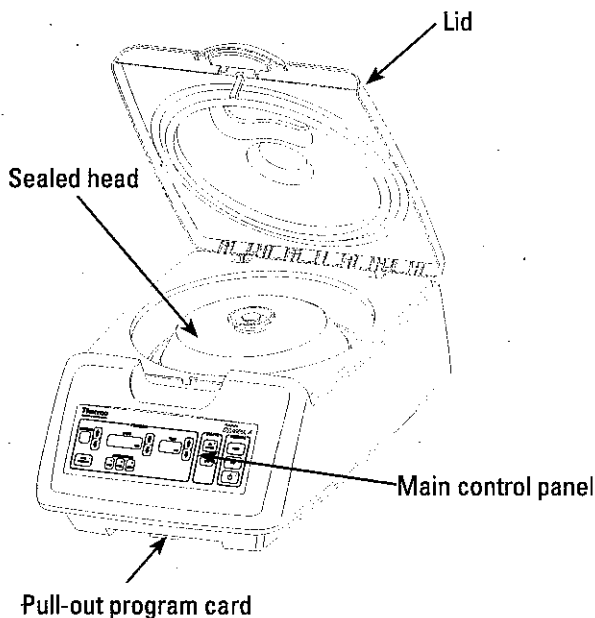

Special design features of the Shandon Cytospin 4 include:

- 1 Lid release mechanism that allows for easy one-handed opening of the Shandon Cytospin 4 to load and unload the sealed head
- 2 New control panel for easy user interface.
- 3 An intuitive way to set programs and interact with all Shandon Cytospin 4 applications
- 4 Additional visual and audible indicators that help to trouble-shoot the instrument

Description

- 5 Fully programmable memory - up to 23 programs can be easily stored and recalled
- 6 A pull-out program card allows you to easily reference each program
- 7 Power Save feature

The only routine maintenance of the Shandon Cytospin 4 centrifuge that the operator is required to do is contained in Chapter 5 - Cleaning and Maintenance.

It is recommended that a Maintenance Contract is taken out with the Thermo Service Department or a Thermo approved distributor.

Chapter 3 Installation and Setting Up

The Shandon Cytospin 4 is a precision instrument that must be unpacked and installed with care.

The bench should be rigid and level, and made of a non-flammable material.



THERE MUST BE AT LEAST 300mm OF CLEAR SPACE AROUND SHANDON CYTOSPIN 4. ▲

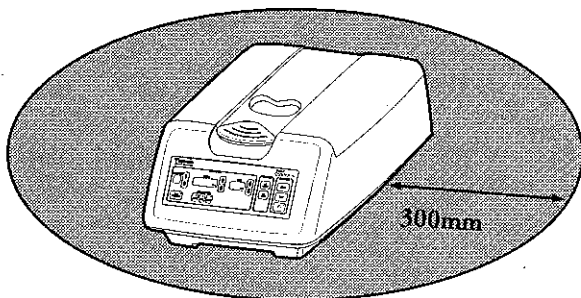

MAKE SURE THE VENTS ON THE SIDES AND UNDERNEATH THE SHANDON CYTOSPIN 4 ARE NOT COVERED. ▲

The bench must be stable and capable of supporting a weight of 12 kg, and the environment must be dust free.

The maximum overall dimensions of the Shandon Cytospin 4 centrifuge are:

Width	405 mm	(16 ins)
Depth	620 mm	(24½ ins)
Height (<i>lid down</i>)	240 mm	(9½ ins)
(<i>lid up</i>)	625 mm	(25 ins)
Weight (<i>with sealed head</i>)	12kg	(26½ ins)

WARNING

The Shandon Cytospin 4 weighs approximately 12 kilograms. If necessary, get help to safely move or lift the instrument without risk of injury. ▲

Unpacking

If the packaging has been damaged, check the condition of the instrument. Contact your Thermo dealer if there is any damage.

Remove the starter kit box (if supplied). Remove the top layer of packaging from the Shandon Cytospin 4. Get help if necessary to lift the instrument from the box and to place it on the bench.

To lift or move the Shandon Cytospin 4, hold the instrument securely under the sides of the unit:

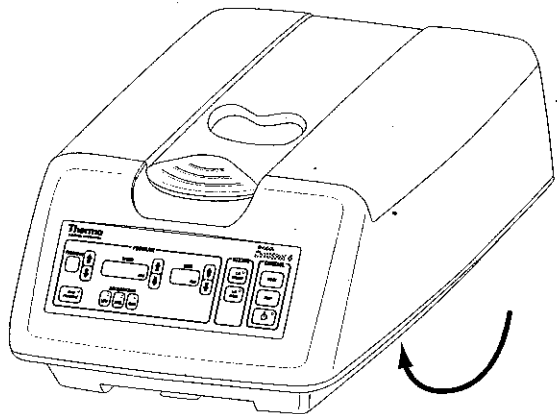

Make sure that you have received all the parts listed on the packing list supplied with the instrument. Contact your Thermo dealer if necessary.

Note Inform your Thermo dealer immediately if there are any breakages or shortages. Quote the instrument serial number, your order number, invoice number, delivery note (or packing slip) number and the date. ▲

Note If you ever need to transport the instrument, refer to Appendix C for instructions about how to repack the instrument. ▲

Opening and Closing the Cytospin 4 Lid

The lid handle is situated at the front of the instrument, with the latch just underneath it.

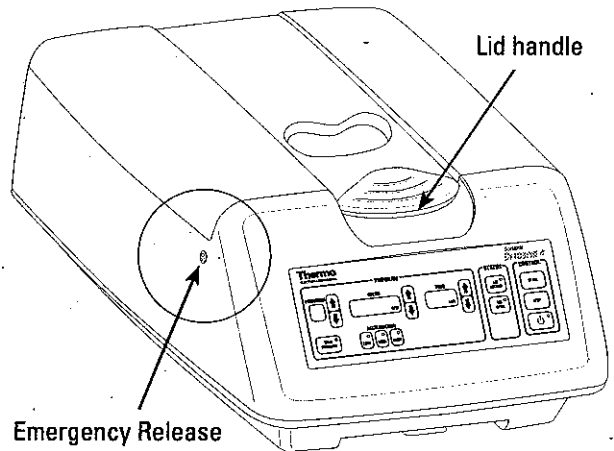

To open the lid, squeeze the lid handle and latch together.

To close the lid, lower the lid and make sure that the lid latch has engaged.

It is necessary to open and close the lid when the Shandon Cytospin 4 is first switched on in order to initialise the instrument. (If the lid is open, it is only necessary to close the lid). The Lid Open LED will flash until this procedure is carried out.

Note If the lid is locked and power is not available, use the Emergency Release.

To use the Emergency Release, remove the small cap on the left side of the instrument:

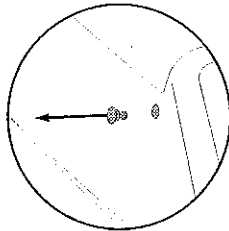

and then insert the lock release tool:

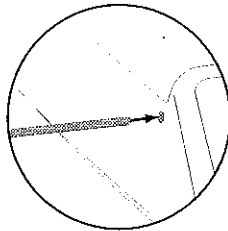

Push the tool inward to release the lock. Then use the lid handle and latch to open the lid. ▲



DO NOT OPEN THE LID IF THE HEAD IS STILL SPINNING. NEVER FORCE THE LID OPEN. ▲

Opening and Closing the Sealed Head

Open the lid and remove the foam packing from the top of the sealed head assembly then lift the sealed head assembly out of the Shandon Cytospin. Remove all the packing pieces.

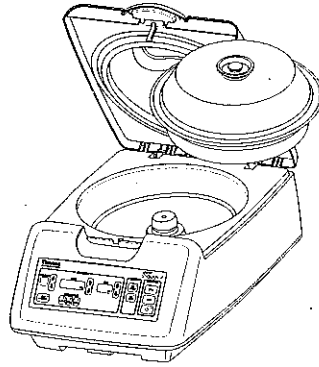

To open the sealed head, pull up the centre button of the lid of the sealed head until it 'clicks', then lift off the lid.

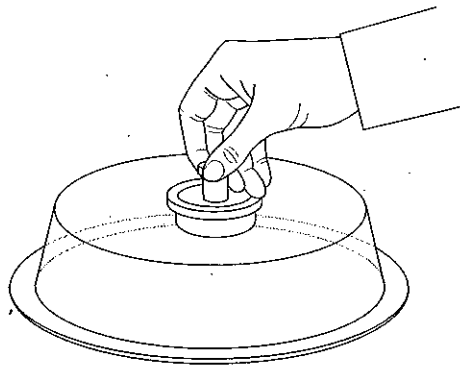

Note *The lid of the sealed head fits snugly in the rubber seal of the base. You may need to tilt the lid gently before you lift it off. ▲*

Note *If necessary, hold the lid of the sealed head with one hand and pull up the centre button with the other. ▲*

To close the sealed head, place the lid in position on the seal of the base. Make sure that the lid sits on the seal correctly. To secure the lid, push down the centre button.

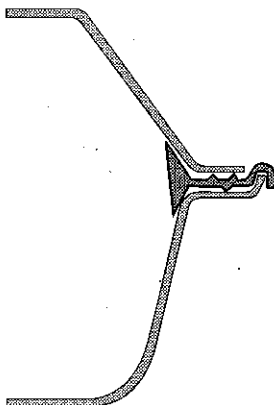



NEVER LIFT THE SEALED HEAD BY THE CENTRAL LOCKING KNOB. ▲

WARNING

To avoid damage to the Shandon Cytospin 4, do not open or close the sealed head assembly when it is installed in the instrument. ▲

Electrical Requirements

Make sure that the voltage of the mains supply corresponds with the voltage rating on the rating plate on the back of the instrument. .

Thermo	93-96 Chadwick Road, Astmoor, Runcorn, Cheshire, WA7 1PR, UK
ELECTRON CORPORATION	
Product:	SHANDON CYTOSPIN® 4
Cat No:	A78300101 Issue 10
Serial No:	CY0018 0201
Nominal Ratings:	100 - 240 V~ 50/60 Hz 150VA
Fuse Rating:	2 x T5A, 250V
	  C US MADE IN UK

Note The - symbol on the rating plate indicates that the instrument operates on an alternating current supply (a.c.). ▲

Make sure that the I / O power switch at the rear of the instrument is switched off (O side of the switch pushed inward).

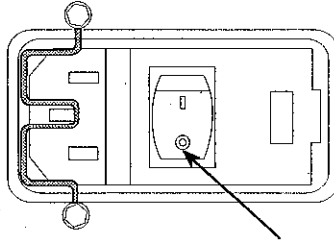

Instruments are supplied with an appropriate power cord with a moulded plug. If another plug is required, it is necessary for a technically competent person to remove the moulded plug from the supplied power cord and fit a suitably rated, and where appropriate, fused plug using the wiring convention shown below:

European cable	US cable	Terminal
Brown	Black	Live (L or L2)
Blue	White	Neutral (N or L1)
Green / yellow	Green	Earth - E, ground or \perp

Insert the power cord into the mains connector on the rear panel of the instrument and clip the cable restraint over the mains connector. Connect the power cord to the local power supply outlet.



US ONLY: FOR 208Vac SUPPLY SYSTEM, CONNECT THE INSTRUMENT TO A CENTRE-TAPPED, SINGLE PHASE SUPPLY CIRCUIT. ▲

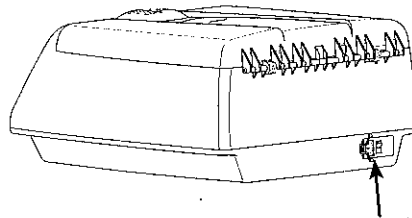

Mains Connector



THE SHANDON CYTOSPIN 4 MUST BE PROTECTIVELY EARTHED. MAKE SURE THAT THE INSTRUMENT IS PLUGGED INTO A PROPERLY EARTHED MAINS SUPPLY. ▲



IT MUST BE POSSIBLE TO INTERRUPT THE MAINS SUPPLY AT SOURCE BY REMOVING THE PLUG FROM THE MAINS SUPPLY SOCKET. ▲



ALWAYS DISCONNECT THE SHANDON CYTOSPIN 4 FROM THE MAINS POWER BEFORE LIFTING OR MOVING THE INSTRUMENT. ▲

Switching On and Off

Follow these instructions to turn the instrument on and off.

To Switch On

Press the I (ON) side of the I/O switch inward to switch the instrument on.

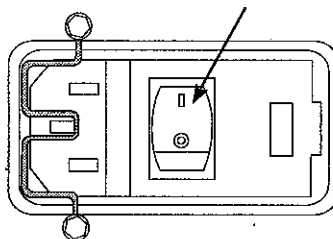

When the Shandon Cytospin 4 is switched on, you should notice the following:

- 1 All the displays and LEDs will light.
- 2 The power up tune will be played
- 3 The last program used will be displayed.
- 4 The Lid Open LED will flash

To Switch Off

When the instrument is regularly used, the instrument should be switched off by using the Standby button  on the Main Control Panel.

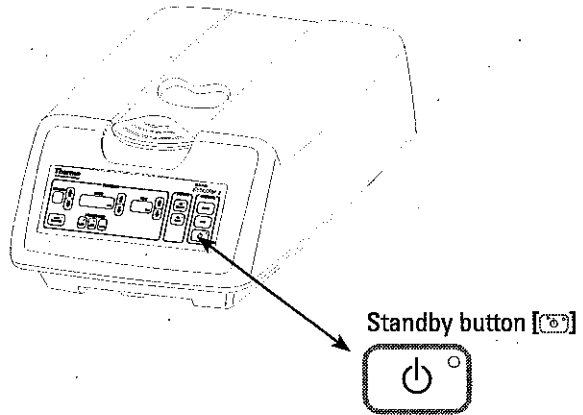

Note The red LED is lit when the instrument is in Standby mode. ▲

To restart the instrument, press the  button again. The displays will show the previous settings.

If the instrument is to be left unattended for long periods of time, or is to be moved, the power to the instrument should be turned off. Press the **O (OFF)** side of the power switch to switch off the Shandon Cytospin 4.

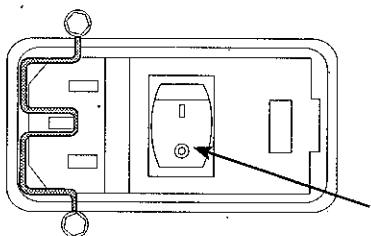

Accessories

The following accessories are available for the Shandon Cytospin 4.

Shandon EZ Single Cytofunnel

The Shandon EZ Single Cytofunnel is a single use, disposable sample chamber.

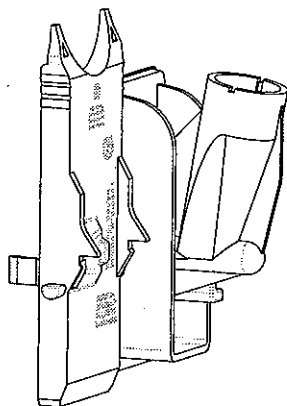

There are two versions of the Shandon EZ Single Cytofunnel:

White filter card

- for sample volumes up to 0.5ml
- filter card for high absorbency

Brown filter card

- for sample volumes up to 0.4ml
- filter card for low absorbency - excellent for scanty specimens such as CSF

Note *Use only 1.0mm thick glass slides.* ▲

The Shandon EZ Single Cytofunnel is loaded, spun and unloaded as described in Chapter 5 - Operation.



MAXIMUM RUN DURATION FOR SHANDON EZ SINGLE CYTOFUNNELS IS 60 MINUTES. IF THIS IS EXCEEDED, THERE IS A SMALL RISK THAT THE SLIDE MAY CRACK. ▲



BE AWARE OF SAMPLES USED. THEY MAY POSE A BIO HAZARD. ▲

Shandon EZ Double Cytofunnel

The Shandon EZ Double Cytofunnel is a single use, disposable sample chamber that allows 2 samples to be prepared at the same time.

A maximum of 0.25ml of sample can be loaded into each side of the double cytofunnel (0.5ml in total).

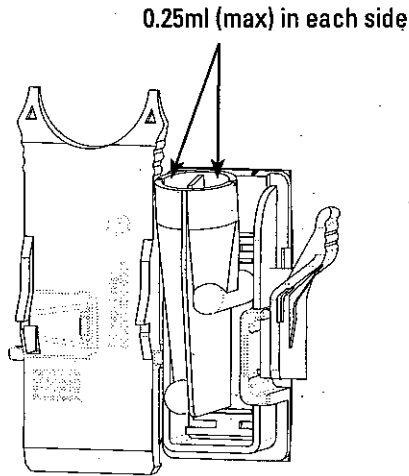

Note *It is recommended that the same sample is used in each side of the Shandon EZ Double Cytofunnel. ▲*

The Shandon EZ Double Cytofunnel is loaded, spun and unloaded in the same way as the Shandon EZ Single Cytofunnel described in Chapter 5 - Operation.



MAXIMUM RUN DURATION FOR SHANDON EZ DOUBLE CYTOFUNNELS IS 60 MINUTES. IF THIS IS EXCEEDED, THERE IS A SMALL RISK THAT THE SLIDE MAY CRACK.▲



BE AWARE OF SAMPLES USED. THEY MAY POSE A BIO HAZARD. ▲

Shandon EZ Megafunnel

Shandon EZ Megafunnels are single use, disposable sample chambers designed for larger volumes of fluids (0.5ml - 6ml).

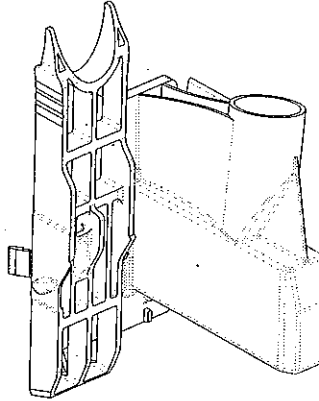

Load and spin the samples in the same way as the Single Shandon EZ Cytofunnel (described in Chapter 5 - Operation).

When the Shandon Cytospin has stopped spinning, remove the sealed head to a safe and convenient area. Make sure the sealed head is kept level.

Installation and Setting Up

Remove each Shandon EZ Megafunnel from the sealed head. Make sure that you keep the EZ Megafunnel tilted away from the slide to prevent the excess fluid touching the filter paper and slide.

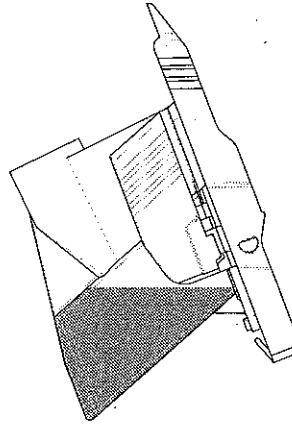

Press the release lever so that the lock catch is released. This allows the funnel to be opened and the slide carefully removed. Pour off the excess fluid from the Megafunnel.

Discard the EZ Megafunnel directly into the appropriate waste receptacle depending on the specimens and materials used, according to your local laboratory procedure.

Hold the slide with the rectangular cell deposition area upward. Place on the bench for 5 minutes. (Depending on the application, slide preparations may be air-dried, spray fixed or placed into 95% alcohol). Stain the slide as required.

Note Spray fixed slides or preparations that used Shandon Cytospin® collection fluid should be placed into 95% alcohol for 10 minutes (to remove the Carbowax®) before proceeding with the staining procedure. ▲

Note Store unused EZ Megafunnels in a clean, dry environment before use. ▲



MAXIMUM SPEED FOR SHANDON EZ MEGAFUNNELS IS 1500 RPM. IF THIS IS EXCEEDED, THERE IS A SMALL RISK THAT THE SLIDE MAY CRACK. ▲



BE AWARE OF SAMPLES USED. THEY MAY POSE A BIO HAZARD. ▲

Chapter 4 Controls

This chapter describes the functions of all the controls on the instrument.

Main Control Panel

The Main Control Panel is situated on the front of the instrument.

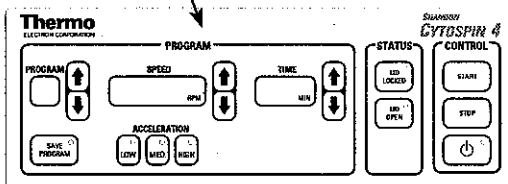
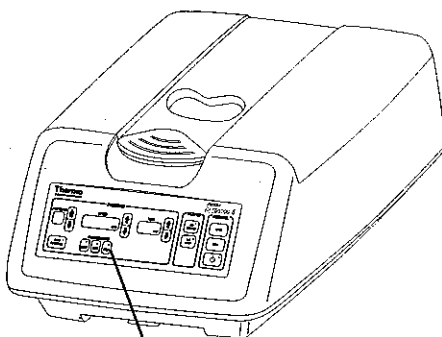

Program Keypad

This keypad allows the user to select or save a program, set the speed, time and rate of acceleration for a run.

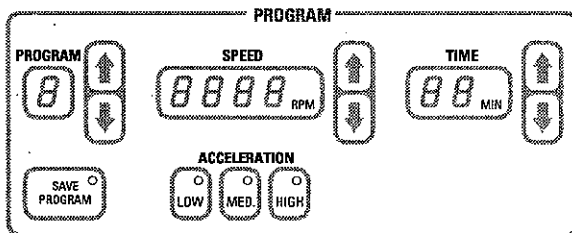

Program The display shows the program selected. Up to 23 programs can be stored, indicated by the following numbers and letters:

1, 2, 3, 4, 5, 6, 7, 8, 9,

A, c, d, E, F, H, L, n, o, P, r, t, u, Y

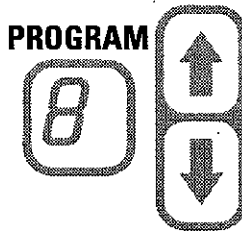

The up arrow increments the program indicator; the down arrow decrements the program indicator.

Note The instrument has programs loaded at the factory. The program locations can be overwritten. ▲

Speed The display shows the run speed in revolutions per minute (rpm) (from 200 to 2000 rpm).

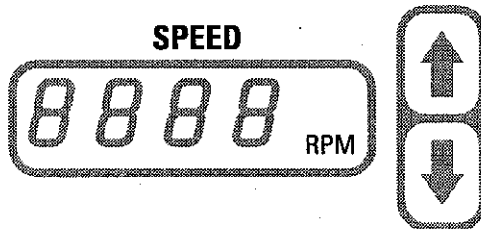

The up arrow increments the speed. If it is pressed once, the speed will be increased in steps of 10 rpm.

The down arrow decrements the speed. If it is pressed once, the speed will be decreased in steps of 10 rpm.

If either button is held down, the speed will be incremented or decremented in steps of 50 rpm.

Time The display shows the run time in minutes (from 1 to 99 minutes).

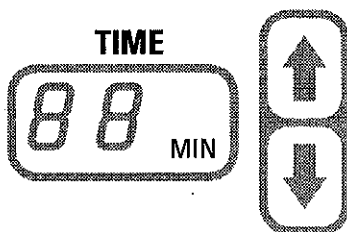

The up arrow increments the time. If it is pressed once, the time will be increased in steps of 1 minute.

The down arrow decrements the time. If it is pressed once, the time will be decreased in steps of 1 minute.

If either button is held down, the time will be incremented or decremented in steps of 10 minutes.

Acceleration Press [LOW]; [MED.] or [HIGH] to select the rate of acceleration required. The LED will light to show which rate has been selected.

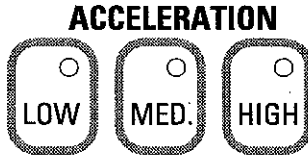

Save Program The [SAVE PROGRAM] button stores the set time, acceleration and speed information into the program selected.



The LED will flash if a program or amended program have not been saved. The LED will switch off when the program is saved.

End of Run Specimen Warning This warning is a safety feature to protect the specimen in the Shandon Cytospin 4 after the program has finished.

When the program has finished, a tune will be played to alert the operator. If it is likely that the operator will be away from the Shandon Cytospin 4 when the program is due to finish, it is possible to program the Shandon Cytospin 4 to repeat the 'end of run' tune at 1 minute intervals.

To repeat the tune at 1 minute intervals, hold down the speed up arrow [↑] when the Shandon Cytospin 4 is switched on at the mains.

To disable the tune repeat, hold down the speed down arrow [↓] when the Shandon Cytospin 4 is switched on at the mains.

Control Keypad

This keypad allows the user to start or stop a run and to switch the instrument into standby mode.

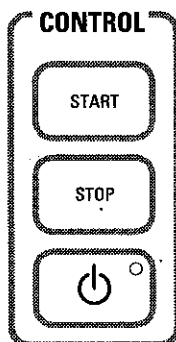

Start Press [START] to begin a run using the parameters selected on the Program Keypad.



Stop Press [STOP] to interrupt the program that is currently running.



Standby Press [⏻] to switch the instrument into standby mode. The red LED will light when standby is selected and all other displays and LEDs will be turned off.



Press [⏻] again to restart the instrument. The instrument will revert to the previous setup information.

Status Display This display area allows the user to see if the lid is locked or open.

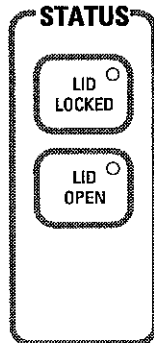

Lid Locked The LED will light if the lid is locked.

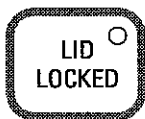

Note *The lid is automatically locked during a run. ▲*

Lid Open The LED will light if the lid is open.



Controls

Chapter 5 Operation

Shandon Cytospin 4 uses centrifugal force to deposit a monolayer of cells in a defined area on glass slides. It effectively by-passes the difficulties normally associated with depositions obtained by direct smear or filtration.

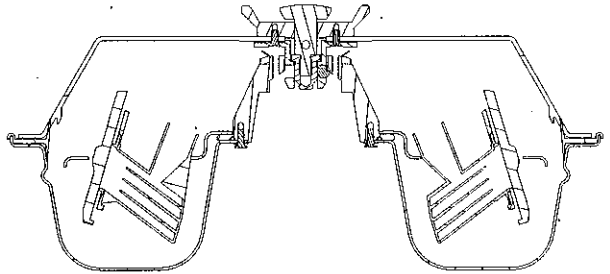

Maximum protection for the operator is ensured by completely containing potentially hazardous specimens in a sealed head assembly. In addition, individual funnel caps give the user another layer of protection from aerosols.



ALWAYS LOAD AND UNLOAD THE SEALED HEAD IN A BIOLOGICAL SAFETY CABINET. AFTER SPINNING, TAKE THE SEALED HEAD TO THE SAFETY CABINET TO OPEN IT. THIS IS PARTICULARLY IMPORTANT IF THE SAMPLES UNDER INVESTIGATION CONTAIN, OR COULD CONTAIN, PATHOGENIC MICRO-ORGANISMS. ▲

WARNING

Shandon Cytospin 4 has been designed with safety in mind. However, if it is not used in accordance with the instructions in this Operator Guide, the protection may be impaired. ▲

Operation

Pencil marking of frosted end slides is a common method for identifying samples and is a recommended practice that takes into account the expected use of the slide.

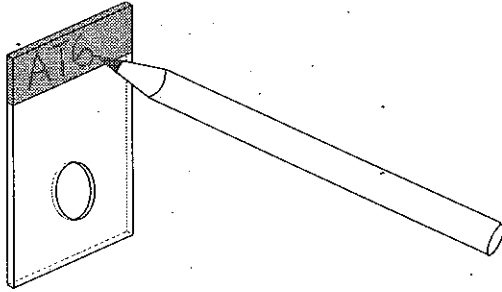

The instrument should be regularly cleaned, disinfected and sterilized as described in Chapter 6.

Each laboratory has its own techniques for preparing cells. The following table - 'Shandon Cytospin 'g' Forces' - provides helpful information regarding the forces generated in Shandon Cytospin 4. The 'g' forces quoted apply at the face of the slide that receives the cells.

Note Single user validated procedures are available for guidance upon request from Thermo. Methodology guidelines are included in Appendix B. ▲

Table 1. Shandon Cytospin 'g' Forces

Speed (rpm)	Force (g)	Speed (rpm)	Force (g)
200	5	1150	149
250	7	1200	163
300	10	1250	176
350	14	1300	191
400	18	1350	206
450	23	1400	221
500	28	1450	237
550	34	1500	254
600	41	1550	271
650	48	1600	289
700	55	1650	307
750	64	1700	326
800	72	1750	346
850	82	1800	366
900	91	1850	386
950	102	1900	408
1000	113	1950	429
1050	124	2000	452
1100	137		

Running the Shandon Cytospin 4

Follow these simple steps to run a program on the Shandon Cytospin 4:

- 1 Load the samples into the sealed head. Fit the lid onto the sealed head and place it in the Shandon Cytospin 4. Close the instrument lid.

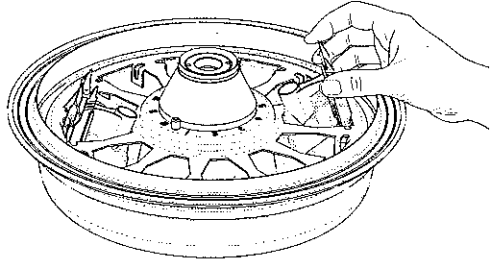

Then, either point 2, followed by point 6:

- 2 Use the arrows to select an existing program.

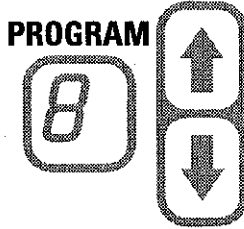

Or points 3, 4, 5, 6:

- 3 Enter the time required.

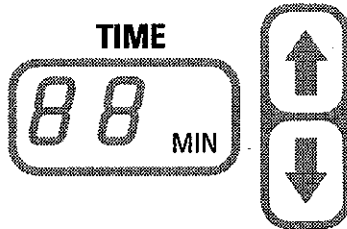

- 4 Enter the speed required.

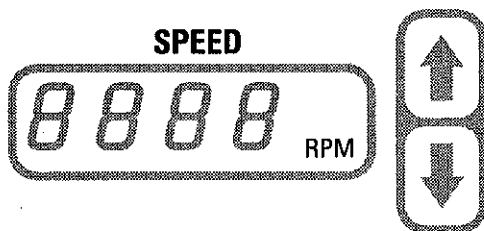

- 5 Choose the rate of acceleration required.

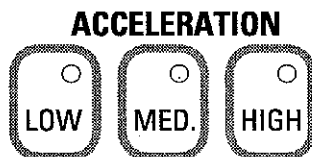

Then

- 6 Press [START] to begin the run.



Note The run will stop automatically once the program has finished. However, if it is necessary to stop the run prematurely, press [STOP]. ▲

Note If you want to save the parameters that have been entered, press [SAVE]. The information will be saved in the program location that is currently displayed (see page 45). Take care - this will overwrite the program information currently saved under that program number. ▲

Loading the Shandon Cytospin 4

Follow the instructions below to load the Shandon EZ Cytofunnels and the Shandon Cytospin 4.

Loading the Disposable Shandon EZ Cytofunnel

- 1 Fit the glass slide as shown. Make sure the slide is correctly oriented with the frosted label end to the top and the frosted side towards the EZ Cytofunnel.

Single and Double EZ Cytofunnel

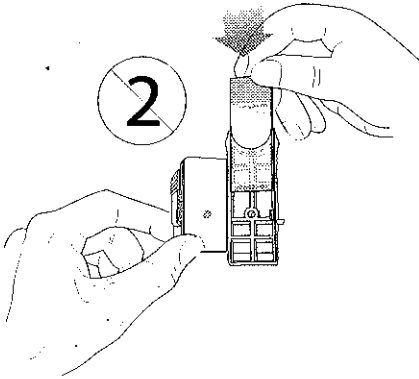

EZ Megafunnel

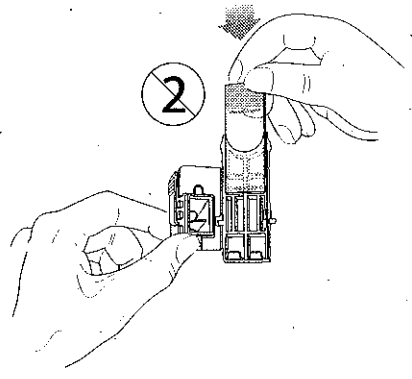

- 2 To close the single or double EZ Cytofunnel, pivot the slide carrier part towards the funnel and press the two halves together. It should close with a positive locking action and an audible click should be heard.

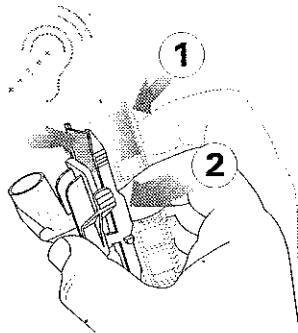

Note *Press on the raised frame around the funnel and not on the funnel itself.* ▲

- 3 To close the EZ Megafunnel, use both hands. Hold the funnel firmly with one hand and pivot the slide carrier part towards the funnel. Press the two halves together. It should close with a positive locking action and an audible click should be heard.

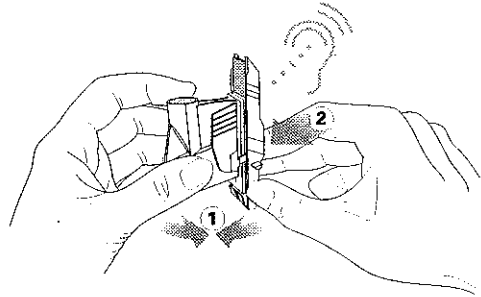

Note *The EZ Cytofunnels have filter cards and gaskets permanently attached to simplify loading and unloading and are designed to be used only once.* ▲

To remove the slide from the EZ Cytofunnel, press the release lever so that the lock catch is released. Open the EZ Cytofunnel and carefully remove the slide.

For EZ Megafunnels only: pour off any excess fluid. Fix as appropriate (see page 24).



BE AWARE OF SAMPLES USED. THEY MAY POSE A BIO HAZARD. ▲

Discard the EZ Cytofunnel directly into the appropriate waste receptacle depending on the specimens and materials used, according to your local laboratory procedure. Do not use the EZ Cytofunnels more than once.

Loading the Sealed Head

To load the sealed head, remove the lid and place up to 12 EZ Cytofunnel assemblies into the slots. Make sure the EZ Cytofunnel assemblies are correctly fitted into the sealed head and that they remain tilted forward.

Note *To remove and replace the sealed head lid, refer to the instructions in Chapter 3 (page 15). ▲*



ALWAYS KEEP THE SEALED HEAD LEVEL WHEN IT CONTAINS SPECIMENS. ▲



TO AVOID AN OUT OF BALANCE ERROR (Err 03):

- 1 MAKE SURE THAT THE CYTOFUNNEL ASSEMBLIES ARE EVENLY DISTRIBUTED IN THE SEALED HEAD TO ENSURE THE SEALED HEAD IS BALANCED - for example, place Cytofunnel assemblies into positions 1, 5 and 9 if only three Cytofunnel assemblies are available, or positions 1, 4, 7 and 10 if only 4 Cytofunnel assemblies are available.**

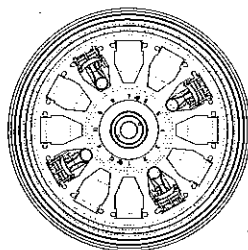
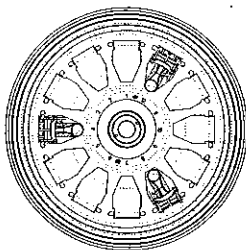

2 DO NOT USE DIFFERENT SIZED CYTOFUNNELS IN THE SAME SEALED HEAD. ▲

Note *When an EZ Cytofunnel assembly is placed into the Support Plate in the sealed head, the chamber is kept at a suitable angle to keep the sample away from the filter paper. ▲*

When the Shandon Cytospin 4 is started, the EZ Cytofunnels will swing into an upright position that allows the cells to be spun onto the slide.

Make sure that the EZ Cytofunnel assembly is in the rest (tilted) position and carefully load the standard EZ Cytofunnel by pipette with between 0.1ml and 0.5ml (maximum) of cells in suspension (0.5ml - 6ml (maximum) for EZ Megafunnels - see Chapter 3 page 23).



**BE AWARE OF SAMPLES USED. THEY MAY POSE A
BIO HAZARD. ▲**

Note *Do not fill the EZ Cytofunnels with more than the amounts specified below:*

<i>EZ Single Cytofunnel (white filter card)</i>	<i>0.5ml (maximum)</i>
<i>EZ Single Cytofunnel (brown filter card)</i>	<i>0.4ml</i>
<i>EZ Double Cytofunnel</i>	<i>0.25ml (each side)</i>
<i>EZ Megafunnel</i>	<i>6ml (maximum). ▲</i>

Note *Caps can be placed on the funnels to avoid spillage. ▲*

Note *Store unused EZ Cytofunnels in a clean, dry environment before use. ▲*

Replace the lid of the sealed head and push down the centre button to lock.



MAKE SURE THAT THE SEALED HEAD LID IS SECURELY FITTED. ▲

Open the Shandon Cytospin 4 lid (see Chapter 3). Lift the sealed head by the centre knob and carefully place it on the tapered boss in the centre of the Shandon Cytospin 4. Close the Shandon Cytospin lid.



Use only Shandon Cytospin accessories from Thermo. Failure to do so may result in unsafe operation and/or give inaccurate diagnostic information. ▲

Selecting a Program

To select a program, use the arrows to step through the programs that have been saved.

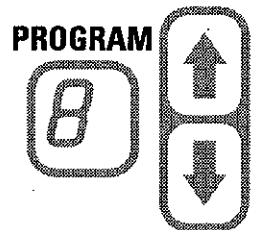
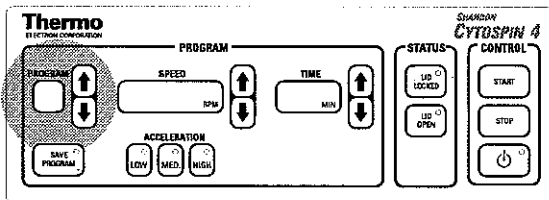

Up to 23 programs can be saved using the following numbers and letters to identify them:

- 1, 2, 3, 4, 5, 6, 7, 8, 9,
A, c, d, E, F, H, L, n, o, P, r, t, u, y

The settings for each program will be displayed. When the required program is displayed, press [START] to begin.

Saving a Program

Note *An existing program may be overwritten. ▲*

To save a program, select a program number.

Enter the required time, speed and acceleration choices as described in following paragraphs.

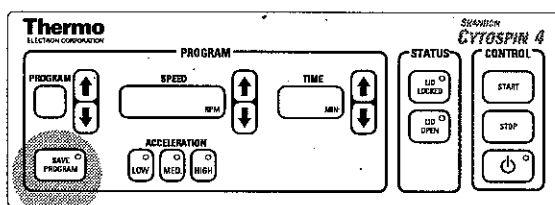

Press [SAVE PROGRAM].

Note *The Pull-out Card is intended for you to note down program information for up to 9 programs. Use a water soluble felt pen (supplied with the instrument) to update the program information. ▲*

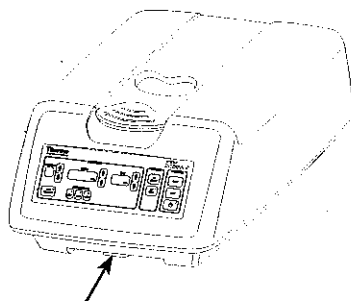

Pull out card

Note *If a program is altered in any way, the LED on the [SAVE PROGRAM] button will flash either until the program is saved, or until another program is selected. Any changes will be lost if the program is not saved.*

If the program that is currently displayed has been saved, the LED on the [SAVE PROGRAM] button will remain OFF. ▲

Entering the Time Required

To enter the time, use the arrows to alter the display. The display shows the current time in minutes (from 1 to 99 minutes).

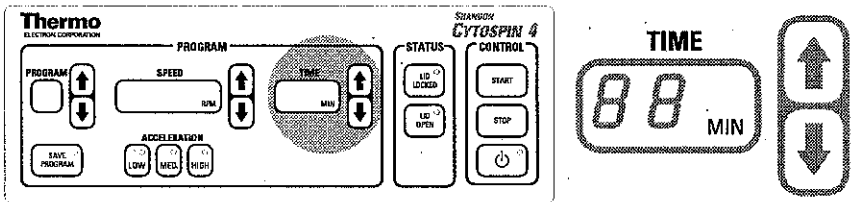

The up arrow increments the time. If it is pressed once, the time will be increased in steps of 1 minute.

The down arrow decrements the time. If it is pressed once, the time will be decreased in steps of 1 minute.

If either button is held down, the time will be incremented or decremented in steps of 10 minutes.



MAXIMUM RUN DURATION FOR SHANDON EZ SINGLE AND DOUBLE CYTOFUNNELS IS 60 MINUTES. ▲

Entering the Speed Required

To enter the speed, use the arrows to alter the display. The display shows the current speed in rpm (revolutions per minute) (from 200 to 2000 rpm).

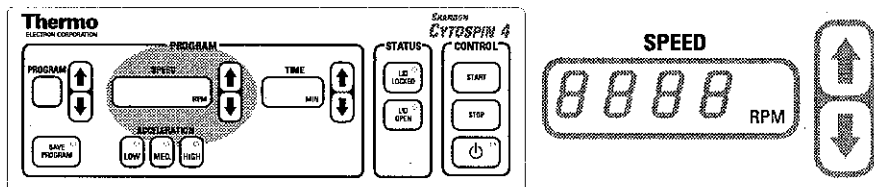

The up arrow increments the speed. If it is pressed once, the speed will be increased in steps of 10 rpm.

The down arrow decrements the speed. If it is pressed once, the speed will be decreased in steps of 10 rpm.

If either button is held down, the speed will be incremented or decremented in steps of 50 rpm.



MAXIMUM SPEED FOR SHANDON EZ MEGAFUNNELS IS 1500 RPM. ▲

Entering the Acceleration Required

Press the [LOW], [MED.] or [HIGH]. to select the rate of acceleration required. The LED will light to show which rate has been selected.

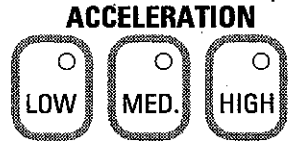
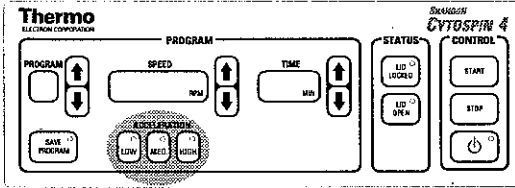

Starting a Run

Make sure that a correctly balanced head is loaded into the Shandon Cytospin 4. Close the lid.

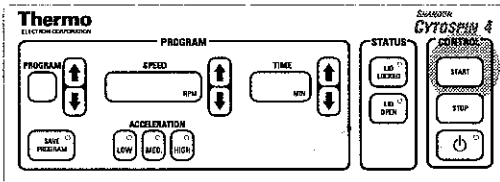

Select or enter the required program and press [START].

The lid will lock automatically and the head will accelerate to the programmed speed. The speed will be maintained for the programmed time and then the head will slow down until it has stopped.

When the head has reached a safe speed (less than 20 rpm) and has almost stopped, the lid will unlock automatically and can be opened.

Unloading the Shandon Cytospin 4

To remove the sealed head from the Shandon Cytospin 4, allow the instrument to stop spinning. Open the lid and remove the sealed head to a biologically safe cabinet. Only open the sealed head assembly in a biologically safe cabinet.



BE AWARE OF SAMPLES USED. THEY MAY POSE A BIO HAZARD. ▲

Error Codes, Audible Tones and Warnings

If an error occurs while the Shandon Cytospin 4 is operating, a warning tone will be sounded and the relevant error code will be displayed in the Speed and Time windows. The error codes are detailed in Chapter 7 - Troubleshooting.

Speed and Time windows

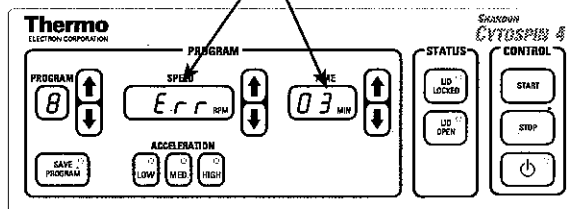

The Shandon Cytospin 4 will also play tunes or tones during the normal operation of the instrument, for example when the instrument is switched on, a key is pressed or held down, or at the end of a run.

Chapter 6 **Cleaning and Maintenance**

Shandon Cytospin is designed for easy maintenance and most fixed components such as the lid, the bowl liner, the control panel and the outer housing are cleaned using a proprietary mild detergent solution applied with a soft cloth.

All components and accessories that are likely to become contaminated are also easily cleaned with proprietary mild detergent solutions after decontamination. It is recommended that you follow the suggested methods of decontamination in parallel with your local procedures.

For the continued safe and efficient operation of the instrument, it is important that regular inspection of the instrument during the following cleaning and maintenance procedures is carried out.



IF HAZARDOUS MATERIAL IS SPILT ON, OR INSIDE, THE INSTRUMENT, THE USER SHOULD CARRY OUT THE APPROPRIATE DECONTAMINATION (see World Health Organisation 'Laboratory Biosafety Manual'). ▲



CLEANING OR DECONTAMINATION METHODS, OTHER THAN THOSE RECOMMENDED IN THE OPERATOR GUIDE, SHOULD BE CHECKED WITH A THERMO AGENT TO ENSURE THAT THE PROPOSED METHOD WILL NOT DAMAGE THE EQUIPMENT. ▲

WARNING

Always wear protective gloves when you clean or decontaminate the Shandon Cytospin to protect yourself against infection or the effects of chemicals. ▲

WARNING

Do not clean or decontaminate by methods that are not recommended by Thermo. ▲

WARNING

Do not use any chemicals that interact with materials of manufacture. If in doubt, check with Thermo Service Department. ▲

WARNING

Phenol and hypochlorites in strong solution will damage the instrument and its accessories. ▲

WARNING

Do not use abrasive compounds or metal components to clean Shandon Cytospin or its components and accessories. ▲

Whenever the instrument has been cleaned, make sure that there is a thin film of silicone grease on the sides of the drive boss. The grease helps to make sure that the sealed head sits securely on the drive boss. If necessary, apply a very small amount of silicone grease (Thermo part number P01913) onto the sides of the drive boss.

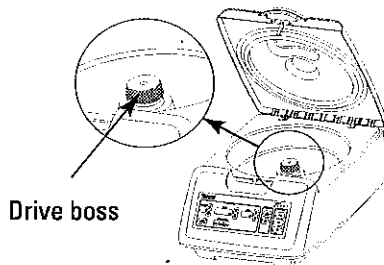

Recommended Materials

If you use any cleaning materials not recommended in this Operator Guide, please check with Thermo Service Department first.



ALWAYS WIPE UP ANY SPILLS IMMEDIATELY. IN THE EVENT OF A MAJOR SPILLAGE, DISCONNECT THE INSTRUMENT FROM THE MAINS SUPPLY WITHOUT DELAY AND DO NOT RECONNECT AND SWITCH ON UNTIL THE INSTRUMENT HAS BEEN THOROUGHLY DRIED OUT AND CHECKED BY A SERVICE ENGINEER. ▲

WARNING

Do not use xylene, toluene or any other similar solvent. ▲

Most proprietary disinfectants in common laboratory use, such as Clorox®, or commercial disinfectants diluted with 0.3% bicarbonate buffer at 7.0 to 8.0 pH, should be suitable.

Allow disinfectant to contact a contaminated surface for at least one hour, where practicable, to ensure decontamination.

WARNING

Any accidental spillage of stains on the touch control panel should be removed by immediately wiping with a cloth and a small amount of alcohol. ▲



POTENTIALLY LETHAL VOLTAGES ABOVE 110Va.c. ARE PRESENT INSIDE THE UNIT. DO NOT REMOVE ANY ACCESS COVERS. ▲

Routine Cleaning and Maintenance

The following table describes the cleaning instructions for the different areas of the Shandon Cytospin 4.



THE FOLLOWING INSTRUCTIONS ARE THE RECOMMENDATIONS OF THERMO. IF ANOTHER CLEANING METHOD IS REQUIRED, PLEASE CONTACT THERMO. ▲

WARNING

Remove the mains plug from the supply socket before you clean the fixed components of the instrument. ▲

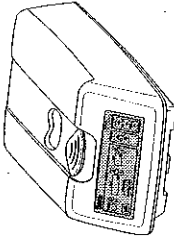
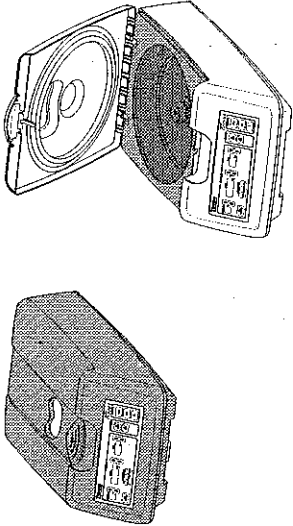
Part	Frequency	Check	Decontaminate	Clean	Avoid
Front Panel 	Weekly or after spillage			Use warm soapy water on a dampened cloth or sponge Apply 10% commercial bleach in water on dampened cloth or sponge	Abrasive powders Xylene, toluene or similar solvents
Lid, Case, Plinth and Bowl Liner 	Daily or after serious spillage	Check that no parts are cracked or damaged		Use warm soapy water on a dampened cloth or sponge Apply 10% commercial bleach in water on dampened cloth or sponge	Abrasive powders Xylene, toluene or similar solvents

Part

Frequency

Check

Decontaminate

Clean

Avoid



IT IS IMPORTANT THAT THE INSTRUCTIONS FOR THE SEALED HEAD ASSEMBY AND SEALED HEAD LID AND BASE ARE FOLLOWED IF THE SEALED HEAD ASSEMBLY IS TO CONTINUE TO ACT AS AN EFFECTIVE BIOSAFETY SEAL. ▲

Sealed Head Assembly

Daily, if necessary, and immediately after serious spillage	Check that no parts are cracked or damaged	Detergents not suitable for non-ferrous metals (for example Decon 90)
---	--	---

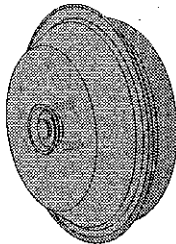

Autoclave all the sealed head, its components and accessories at 121°C (250°F) for 15 minutes. Unlock the lid so that the steam can fully penetrate the interior	After autoclaving, wash the sealed head and its components and accessories in warm soapy water. Dry in an oven at a temperature not exceeding 65°C (149°C)
--	--

Alternatively, submerge the sealed head base in a 10% solution of commercial bleach in water for no less than 1 hour

Part	Frequency	Check	Decontaminate	Clean	Avoid
Sealed Head Base	Daily, if necessary, and immediately after serious spillage	Check that the base is not dented or damaged	Autoclave at 121°C (250°F) for 15 minutes	After decontamination, wash the Support Plate in warm soapy water. Rinse in clear water then dry	The use of hard brushes Detergents not suitable for non-ferrous metals (for example Decon 90)
	Weekly	Remove the silicone rubber lid seal from around the rim of the base and clean the surface of the rim. Replace the seal		Alternatively, submerge the sealed head base in a 10% solution of commercial bleach in water for no less than 1 hour	
	Annually	Fit a replacement lid seal			

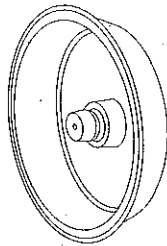

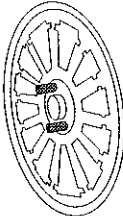
Part	Frequency	Check	Decontaminate	Clean	Avoid
<p>Support Plate</p> <p>To gain access to the underside of the support plate, undo and remove the two thumb screws, then lift up and remove the support plate.</p> 	Daily,		Autoclave at 121°C (250°F) for 15 minutes	<p>After decontamination, wash the Support Plate in warm soapy water. Rinse in clear water then dry</p> <p>Alternatively, submerge the sealed head base in a 10% solution of commercial bleach in water for no less than 1 hour</p>	The use of hard brushes

Part	Frequency	Check	Decontaminate	Clean	Avoid
Sealed Head Lid	Daily, if necessary, and immediately after serious spillage	Check that the lid is not cracked	Autoclave at 121 °C (250 °F) for 15 minutes	After decontamination, wash the Support Plate in warm soapy water.	The use of hard brushes
	Weekly	Clean the surface of the lid.		Rinse in clear water then dry	Abrasive powders Xylene, toluene or similar solvents
	Monthly	Grease the locking ball bearing assembly		Alternatively, submerge the sealed head base in a 10% solution of commercial bleach in water for no less than 1 hour	Detergents not suitable for non-ferrous metals (for example Decon 90)

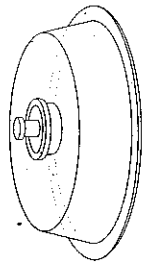

Seal Replacement



IT IS IMPORTANT THAT THE INSTRUCTIONS IN THIS CHAPTER ARE FOLLOWED IF THE SEALS ARE TO CONTINUE TO FORM AN EFFECTIVE BIOSAFETY SEAL. ▲

Three flexible seals are fitted in the sealed head - the cone seal, an O- ring seal, and a lid seal.

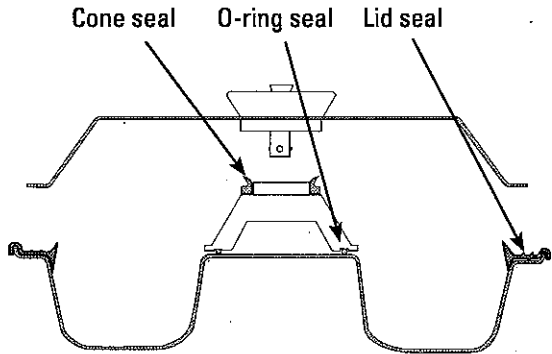

All the seals are designed to withstand normal cleaning and decontamination as part of the routine maintenance of the sealed head. However, the seals eventually become worn, stretched, or degraded by the action of chemicals over a period of time and should be replaced annually. The three seals are available in sealed head spares kit (Thermo part number 59910019).

To remove the sealed head cone seal simply pull the old seal off the cone.

To fit the sealed head cone seal. Stretch the replacement cone seal, with the thin lip uppermost, onto the collar of the centre cone.

Cone seal

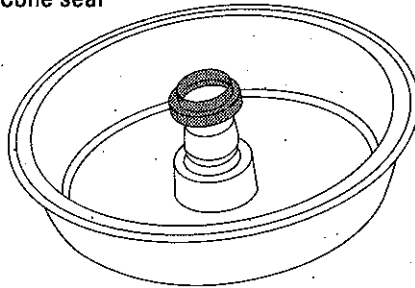

To remove the sealed head O-ring seal, Use a screwdriver to undo the four screws that secure the cone to the base, then remove the cone and lift the O-ring from its groove.

To fit the sealed head O-ring seal. Fit a replacement O-ring seal in its groove in the cone. Make sure that the O-ring fits correctly in its groove then fit the cone to the base. Fit, then tighten, the four screws.

O-ring seal

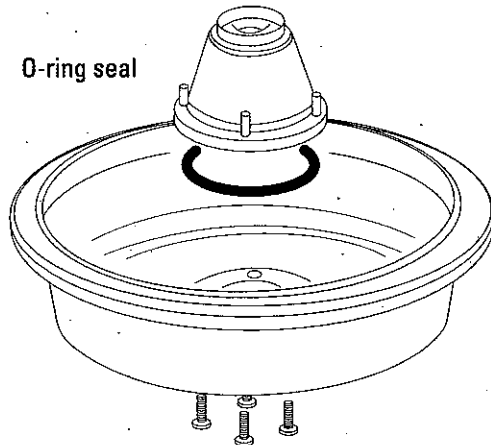

To remove the sealed head lid seal, pull the old seal off the rim of the base.

Lid seal

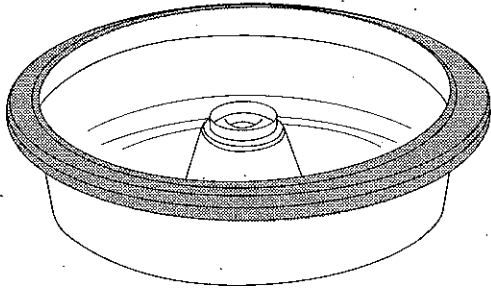

To fit the sealed head lid seal, place the replacement lid seal on the rim of the bowl then push the lip of the seal over the vertical edge at the periphery of the bowl (see lid seal cross section diagram below). Make sure that the seal fits uniformly around the rim.

Lid seal cross section



Chapter 7 Troubleshooting

Correct service and maintenance is essential for the long term serviceability of precision engineered products such as Shandon Cytospin 4. We strongly recommend that a Thermo Service Contract is used to ensure future reliability, and consistency of performance.

Table 1 shows remedial action to be taken if Shandon Cytospin fails to operate.

Table 2 details the error codes and the actions required to clear the errors.

Tables 3 to 6 relate to processing problems and suggested solutions with respect to the preparation of cells by cytocentrifugation.



BE AWARE OF SAMPLES USED. THEY MAY POSE A BIO HAZARD. ▲

Table 1 - Instrument Function

Symptom	Cause	Remedy
Displays not lit on control panel	No power supply	Check the mains supply
	Fuse blown in plug	Replace the mains fuse
	Instrument fuse blown	Replace the instrument fuse (Note - only a technically competent person should replace fuses)
	Instrument is in standby mode - red LED is on	Press 
Programs do not run	Stopped at instrument	Press [START]
	Incorrect programming	Check ranges: 200 -2000 r.p.m. 1 - 99 minutes
	Lid not closed	Close lid

Error Codes

Audible warning tones will sound and error codes will be displayed if the Shandon Cytospin 4 detects a situation that prevents it from working safely and efficiently.

The speed and time windows will display Err 0X where X is the error number detailed in Table 2. For example, Error 3 would be displayed -

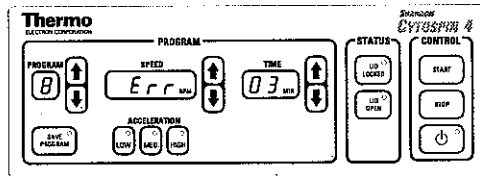

To clear an error, press [STOP] to silence the alarm. When the sealed head has stopped spinning, press [STOP] again to clear the error. When an error has been cleared, the lid of the instrument must be opened and closed.

If an error code is displayed that is not listed in Table 2, turn the instrument off and then on again to clear them.

If any error does not clear, contact the Thermo Service department.

Table 2 - Error Codes

Error Code	Cause	Remedy
Err 01	Lid Error - the lid switch has not operated correctly	<ul style="list-style-type: none"> ● Press [STOP], then open and close the lid
Err 02	Speed Error - the Shandon Cytospin 4 cannot currently maintain the normal tolerance of ± 20 rpm, or has been unable to reach the programmed speed within 1 minute	<ul style="list-style-type: none"> ● Press [STOP], then open and close the lid ● Check that the sealed head is installed correctly and turns freely ● Contact Thermo Service if problem persists
Err 03	Out of Balance Error - the Shandon Cytospin 4 detects that there is a balance error	<ul style="list-style-type: none"> ● Turn the Shandon Cytospin off and then on again, then open and close the lid ● Check sample carrier distribution (page 42) ● Check sealed head for damage ● Check that the sealed head turns freely
Err 04	The battery has discharged or the system memory has been corrupted which has reset the instrument	<ul style="list-style-type: none"> ● Press [STOP], then open and close the lid ● Leave instrument switched on for 24 hours ● Contact Thermo Service if the problem persists
Err 05	Lid Lock released manually during run or the lid solenoid has not operated correctly	<ul style="list-style-type: none"> ● Press [STOP], then open and close the lid
Err 06	Lid was not opened and closed when the power switched on or after an error	<ul style="list-style-type: none"> ● Press [STOP], then open and close the lid

Table 3 - Unsatisfactory Cytocentrifugation Results - Quality

Problem	Cause	Remedy
Before Cytocentrifugation		
Poorly preserved cells	Preserved poorly in vivo	Request repeat specimen
	Lengthy delays between collection and preparation	Minimize delays (e.g. less than 4 hours. Refrigerate if longer)
	Cells suspended in normal saline	Use balanced electrolyte solution
Cells small in diameter; optically dense	Cells collected in high proportion of strong alcohol	Collect unfixed fresh specimens, or mix with equal volume of 50% ethanol
	Alcohol added to sample chamber begins to rise through the cell suspension and causes cell shrinkage when it mixes.	Add less alcohol; add alcohol carefully
RBCs haemolysed; ghosts remain	Alcohol was mixed with cell suspension	Add alcohol carefully to sample chamber
During Cytocentrifugation		
Cells air dried	Cell suspension medium absorbed completely by filter card	Fill cylindrical sample chamber before cytocentrifugation; use Shandon Cytospin Collection Fluid; reduce the cytocentrifugation time and/or speed
Cells air dried around periphery of collection area	Cell suspension medium almost completely absorbed by filter card	Increase specimen volume up to 0.5ml; use Shandon Cytospin Collection Fluid; reduce cytocentrifugation time and/or speed

Table 3 - Unsatisfactory Cytocentrifugation Results - Quality
(Continued)

Problem	Cause	Remedy
After Cytocentrifugation		
Cells air dried	Film of liquid over the cells allowed to evaporate during brief interval between unloading and immersion in alcohol	Move quickly to avoid evaporation of protective film from over the cells
Cells air dried around periphery of collection area	Film of liquid is thinnest at its edges and evaporates before the thick central area	Immerse cells in alcohol before air drying progresses on to periphery of cell area
Disrupted air dried pale cells, resemble 'basket cells' of haematology	Fragile cells air dried and exaggerated by centrifugal force	Request repeat specimen. Do not allow to air dry

**Table 4 - Unsatisfactory Cytocentrifugation Results - Quantity
(number of cells)**

Problem	Cause	Remedy
Before Cytocentrifugation		
No cells	Exit port blocked by filter card (TPX only)	Request repeat specimen
Abnormal cells in specimen but not on cytocentrifuged preparations	Abnormal cells, usually larger and heavier than normal cells, sediment to bottom of concentrate. May be missed if not resuspended completely following conventional centrifugation	Apply centrifuge tube with cell concentrate and several ml of balanced electrolyte solution to vortex mixer and completely re-suspend cells
Too few cells	Too few cells in raw specimen	Enrich by conventional centrifugation. Resuspend cells in 1-2ml balanced electrolyte solution. Combine contents of multiple centrifuge tubes of same specimen when possible. microscopically examine drop of resuspended cell concentrate; Base sample size on cell count. Request repeat specimen; suggest ways to increase cellular harvest
	Too few cells added to sample chamber	Base sample size on cell count of drop of resuspended cell concentrate
	Sparsely populated specimen may have filled the cylindrical and conical portions of the sample chamber	Enrich specimen as described above

Table 4 - Unsatisfactory Cytocentrifugation Results - Quantity
(Continued)

Problem	Cause	Remedy
	Partially filled cone raised level of specimen in cylinder to filter card level where cells can be absorbed	Do not allow distal boundary of specimen to touch filter card before cyto-centrifugation
	Cells crowded out by precipitated hyaluronic acid in joint fluid	Dissolve hyaluronic acid precipitate with pinch of hyaluronidase
	Cells crowded out by precipitated phosphate salts in urine	Mix several drops of glacial acetic acid to lower the pH and redissolve the alkaline pH dependant precipitated phosphate salts
	Cells crowded out by erythrocytes	Use saponin to haemolyse erythrocytes
	Slide is between exit port and filter card (TPX only)	Load in correct sequence; sample chamber filter card side
Too many cells	Too much densely populated cell suspension added to sample chamber	Microscopically examine drop of resuspended cell concentrate; dilute up to 10x if necessary; base sample size on cell count or derive it from hematological counting chamber. Do not rely on visual estimates of specimen appearance

During Cytocentrifugation

Too few cells	Exit port blocked by misaligned filter card (TPX only)	Check alignment as seen through window from back of slide clip; seat filter card
	Cells lost through gap between exit port and filter card	Unlikely; though check assembled unit for alignment

Table 4 - Unsatisfactory Cytocentrifugation Results - Quantity
(Continued)

Problem	Cause	Remedy
After Cytocentrifugation		
Too few cells	<p>Suspension medium absorbed incompletely as a result of filter card becoming clogged by debris in previously non-centrifuged specimen and / or pores collapse from too much pressure from spring or excessive centrifugal force</p> <p>Unabsorbed suspension medium can induce cell wash-off.</p>	<p>Centrifuge specimen at 3000 r.p.m. for 10 min. to sediment cells and leave debris in suspension to be discarded with supernatant. Do not wet blotter before cytocentrifugation. Cytocentrifuge specimen at 1000 rpm for 6-10 min</p> <p>Unload horizontal sample chamber, cell side up. Allow blotter to absorb excess liquid. Lift chamber and blotter away from slide. Lay slide flat until a thin film remains; immerse in fixative</p>

Table 5 - Unusual Pattern of Cell Population Distribution

Problem	Cause	Remedy
Before Cytocentrifugation		
Crescent shaped distribution	Cylinder filled incompletely	Fill cylinder completely
	Cells settle in cylinder if prolonged delay before cytocentrifugation	Rapidly load sample chambers and begin cytocentrifugation immediately
Display area displaced from label end	Slide not seated to foot of Cytofunnel	Seat slide to foot of Cytofunnel
Display area displaced towards label end	Slide placed in Cytofunnel label end down	Insert slide label end up
Cells on underside of slide	Slides loaded backwards	Orient slide with label facing exit port
After Cytocentrifugation		
Cell population streams towards label end or to opposite end	Thinly layered cells too wet and are either pushed up the slide upon immersion in alcohol, or slide down the slide following immersion	Let the suspension medium evaporate almost completely
Circular band of cells, acellular centre, 'Bull's Eye' distribution	Thickly layered cells, margins nearly dry but centre remains very wet and promotes cell wash-off	Add less cell suspension

Table 6 - Summary

To predictably produce cytocentrifuged preparations that exhibit within a 28mm² circle a representative sample of randomly distributed, uncrowded, monolayered, flattened cells that are well preserved and displayed, the materials and methods that follow are recommended:

Before Cytocentrifugation	
DO	DO NOT
Use Unfixed fresh cell suspension	Use cell suspensions collected in alcohol
Saponinize bloody cell suspensions	Use bloody cell suspensions
Equalize differences in cell suspension	Shandon Cytospin un-processed cell suspensions
Control the number of cells	Estimate number of cells
Use clean Micro slides	Use frosted or albumenized micro slides
Use balanced electrolyte solution	Use normal saline
Keep cell suspension from the filter card	Let the cell suspension touch the filter card
Fill sample chambers with similar volumes	Use significantly different volumes
During Cytocentrifugation	
DO	DO NOT
Select a speed, time and acceleration suitable for the specimen type, for example, use lower speeds and acceleration for fragile cells	Centrifuge too rapidly
	Centrifuge too briefly, or for too long
During Cytocentrifugation	
DO	DO NOT
Keep the cells slightly wet	Allow the cells to air dry unless intended
Immerse immediately the cytological preparation in 95% ethanol for ethanol preps	Let too much liquid remain on the cells
Allow the cellular monolayer to air-dry before staining when using Shandon Cytospin Collection Fluid	Immerse in 95% ethanol until the cell monolayers prepared with Shandon Cytospin Collection Fluid have dried sufficiently - unless otherwise specified

Troubleshooting

Chapter 8 Specification, Accessories and Spares

Specification

Physical

Width	405 mm (max)	(16 ins)	
Depth	620 mm	(24½ ins)	
Height	240 mm	(9½ ins)	(lid down)
	625 mm	(25 ins)	(lid up)
Weight	12 kg	(26½ lbs)	

Electrical

Power Supply Voltages 100 - 240 V a.c. (-); 5A 50/60 Hz; 150VA

Note *Maximum supply voltage fluctuations not to exceed ±10% of nominal voltage range. ▲*

Fuses Mains plug fuse 5A 250V (where applicable)
Mains fuses (x 2) T5A 250V
(Thermo part number for Fuse Spares Kit - A78310021)

Note. *Fuses should only be replaced by technically competent personnel. ▲*

Switch Convention I Power On
O Power Off

Sound Power Level <53dB (this should not present any hazard to the user)

Program Details Time 1 - 99 minutes
Speed 200 - 2000 rpm (in increments of 10rpm)
Acceleration High, Medium, Low

Environment

General	Indoor use only
Operating Temperature	+2°C to +40°C
Transit/Storage Temperature	-25°C to +55°C (+70°C for short exposure)
Humidity	80% max. for temperatures <31°C 50% max. for temperatures 31°C to 40°C (<i>Non-condensing environment</i>)
Altitude	up to 2000m (6,500 feet)
Pollution degree	2
Over voltage category	II

Part Numbers

Shandon Cytospin 4	A78300001	(with starter kit)
	A78300002	(without starter kit)

Note *Starter kit comprises:*

Shandon EZ Double Cytofunnels with double Cytoslides

Shandon EZ Single Cytofunnel (White Filter Card) with single Cytoslides

Shandon EZ Megafunnels with slides. ▲

Note *Both versions of Shandon Cytospin 4 come with a sealed head. ▲*

Accessories and Spares

Centrifuge Accessories	Quantity	Part Number
Sealed Head (not including Cytofunnels)	single	59910018

Centrifuge Spares	Quantity	Part Number
Sealed Head Seals	pack of 3	59910019
Note: Each sealed head requires 3 different seals - this pack includes one of each type of seal required. ▲		
Support Plate	single	59920047

WARNING

Use only Shandon Cytospin accessories from Thermo. Failure to do so may result in unsafe operation and/or give inaccurate diagnostic information. ▲

Other Accessories	Quantity	Part Number
Sample Chambers:		
Shandon EZ Single and Double Cytofunnels: (disposable; integral filter cards; packs include caps)		
Single, white filter card	pack of 50	A78710003
Single, brown filter card	pack of 50	A78710004
Double, white filter card	pack of 50	A78710005
Shandon EZ Megafunnel - 6ml (includes caps and slides)	pack of 25	A78710001

Specification and Accessories

Other Accessories	Quantity	Part Number
Cytoslides:		
76 x 26mm glass slides with outlined specimen area and frosted area at one end for identification		
Single circle: coated; circle on back	pack of 100	5991056
Single circle: non-coated; circle on back	pack of 100	5991051
Single circle: non-coated; circle on front	pack of 100	5991059
Double circle: coated	pack of 100	5991055
Double circle: non-coated	pack of 100	5991054
Megafunnel slide: coated rectangle	pack of 25	5991026
Double circle: blue mask	pack of 100	B5991050
Single circle: black mask	pack of 100	5991057
Preparation:		
Shandon Cytospin Collection Fluid:		
10 litre bottles	pack of 2	9990310
4 litre bottle with pump	single	6768001
500 ml bottles	pack of 2	6768315
120 ml cups (filled to 60 ml)	pack of 125	9990323
CytoRich Red Collection Fluid:		
4 litre bottle	single	B9990800
500 ml bottles	pack of 2	B9990801
120 ml cups (filled to 60 ml)	pack of 125	B9990803
20 ml vials (filled to 10 ml)	pack of 180	B9990802
Mucolexx Transport Fluid:		
4 litre Bag-In-A-Box	single	9990371
500 ml bottles	pack of 4	9990370
120 ml cups (filled to 60 ml)	pack of 50	9990375
Shandon Cell-Fixx Spray Fixative:		
50 ml spray bottle	pack of 6	6768326

General Spares	Quantity	Part Number
Service Manual	single	A78310251
Silicone grease (for drive boss)	60g tube	P01913
Standard Workflow Diagram Card	single	A783-1001
Water soluble felt pen	single	A78330031

For more details, please refer to the latest catalogue.

Specification and Accessories

Chapter 9 **Warranty Statement**

We are proud of our quality and reliability, and of our after-sales service. We continuously strive to improve our service to our customers.

Please ask your Thermo distributor or representative about Service Contracts which can keep your purchase in peak condition for many years to come.

Warranty provisions necessarily vary to comply with differences in national and regional legislation, and you can find details in your delivery documents or from your dealer or representative.

Please note that your warranty may be invalidated if:

- the instrument is modified in any way,
- accessories and reagents are used that are not approved by Thermo, or
- the instrument is not operated or maintained in accordance with the instructions in this Operator Guide.

Declaration of Conformity

This Declaration of Conformity is only valid when the instrument is used in accordance with this Operator Guide

Manufacturer's Name: Thermo Electron Corporation
Manufacturer's Address: Chadwick Road, Astmoor, Runcorn,
Cheshire, WA7 1PR, UK
Product Description: Cyto centrifuge
Product Designation: Shandon Cytospin 4
Part Numbers: A78300001, A78300002 *when used with the following accessories:*
Sealed Head: 59910018.
Shandon EZ Single Cytofunnel[®]: A78710003, A78710004
Shandon EZ Double Cytofunnel[®]: 78710005
Shandon EZ Megafunnel[™]: A78710001
Cytoslide[®]: B5991050, 5991051, 5991054, 5991055, 5991056, 5991057, 5991059
Year of Marking (CE): 2002

This product conforms with the essential requirements of the following directives:

In Vitro Diagnostics Directive 98/79/EC

Low Voltage Directive 73/23/EEC *(as amended by 93/68/EEC)*

This product complies with the following International Standards:

EMC: EN61326
EN61000-3-2
EN61000-3-3

Safety: IEC 61010-2-020
IEC 61010-2-101
CAN / CSA - C22.2 No 1010.1-92
UL Std No. 3101.1

Issued by: K. Waldron
Quality Manager
Thermo Electron Corporation
Anatomical Pathology, Clinical Diagnostics



Date: 1 January 2005

Optional accessories considered subject to the In Vitro Diagnostic Directive (IVDD) are specifically identified on this Declaration of Conformity. Further supplies of standard accessories are treated as spares. Convenience aids offered as accessories are not subject to the IVDD

Appendix A Standard Workflow Diagram

SPECIMEN EXAMINATION

Page 89

- Specimen origin - precise anatomical site
- Volume of specimen
- Physical appearance of specimen - colour, viscosity, whether it is homogeneous or contains tissue fragments or blood

DETERMINE THE CELL COUNT

Page 90

The concentration chosen should allow enough space for cells to form a monolayer with minimum overlap, but not leave too much space between cells. Average cells (diameter 10-12 microns) produce excellent Cytospin preparations at cell densities of 1×10^6 cells per ml. Larger cells will require lower concentrations; smaller cells, cell organelles or bacteria will require higher concentrations

CONCENTRATE OR DILUTE THE SPECIMEN AS REQUIRED

Page 94 (to concentrate);

Page 95 (to dilute)

LOAD SHANDON CYTOSPIN SAMPLE CHAMBERS

Pages 40 - 44 and page 95

Place the EZ Cytofunnels into the sealed head. Make sure they are distributed evenly so that the Shandon Cytospin 4 is not out of balance.

Load the EZ Cytofunnels after they have been inserted into the sealed head.

Do not place more than 0.5ml of a sample in an EZ Cytofunnel sample chamber with white filter card (0.4ml for an EZ Cytofunnel sample chamber with brown filter card or 6ml maximum in an EZ Megafunnel). Make sure that the sample is deposited directly into the bottom of the sample chamber - do not allow the sample to drip down the sides of the chamber.



cont...

SELECT THE TIME, SPEED AND ACCELERATION FOR THE SHANDON CYTOSPIN PROGRAM

Pages 44 - 47 and page 96

Average cells will require an approximate speed of 1000 rpm with medium acceleration. Large or fragile cells should be spun at a slower speed (e.g. 500 - 800 rpm) with low acceleration; small cells or bacteria may require higher speeds (e.g. up to 2000 rpm) with high acceleration. Note that the maximum speed for the EZ Megafunnel is 1500rpm.

RUN THE SHANDON CYTOSPIN

Page 48

When the Shandon Cytospin 4 is programmed and the sealed head is loaded, press [START] to start the run

UNLOAD CYTOSPIN SAMPLE CHAMBERS

Page 97

The Shandon Cytospin 4 lid will unlock automatically as soon as the Shandon Cytospin has stopped spinning.

As soon as possible after the Shandon Cytospin has stopped spinning, remove the sealed head from the instrument and open it in a biological safety cabinet. Open the sealed head lid and remove the EZ Cytofunnel assemblies.



FIXATION

Page 98

Fix the samples as soon as possible to avoid autolysis.

STAINING

The specimen can now be stained and examined according to laboratory procedures and examined microscopically.

MICROSCOPY AND DIAGNOSIS



BE AWARE OF SAMPLES USED. THEY MAY POSE A BIO HAZARD. ▲

Appendix B Methodology Guidelines

General Theory

Introduction

The Shandon Cytospin is a special purpose instrument designed to deposit cells on to glass slides. The instrument produces monolayer cell deposition in a defined area of the slide, using centrifugal force. For most cytological specimens the Shandon Cytospin offers significant advantages in specimen retention, preparation, and standardisation, and ease of specimen evaluation.

Cytological specimens may also be deposited on to slides by techniques such as direct smears or by filter techniques. While useful with some specimens, both direct smears and filter techniques have significant disadvantages when compared with Shandon Cytospin preparations.

Direct smears consistently produce preparations of varying thickness from end to end of the smear. In addition, severe mechanical damage may result to many cells within the preparation. There is also a likelihood of selective cell distribution within the smear. Cells of different sizes will be deposited in different areas of the smear.

Filter preparations, while excellent for cell retention, are technically demanding and time consuming. In addition, filter preparations rarely yield slides that can be evaluated easily. The cells are seldom in the same plane as the focus within the microscope, and it is extremely difficult to obtain well stained cells without also staining the filter. For those filter techniques that dissolve the filter, there is a significant risk of cell loss, in addition to the difficulty and hazards of using a volatile and dangerous solvent.

Shandon Cytospin preparations effectively circumvent these difficulties, and consistently produce uniform preparations

of cells that are easily stained and evaluated. In addition, the construction of the Shandon Cytospin ensures maximum containment of potentially hazardous specimens, thereby reducing the risk to laboratory personnel.

Specimens from body fluids and all body sites can be used for Shandon Cytospin preparations. The primary requirements are that the specimen be a cell suspension, preferably of single cells, and that the cells are fresh and intact enough to yield diagnostic information. With proper application of the general principles of Shandon Cytospin operation, consistent preparations of well-preserved cell monolayers should result.

General Laboratory Considerations

The Shandon Cytospin is designed to provide maximum protection to the operator by completely containing potentially hazardous specimens. However, Shandon Cytospin cannot protect the operator during the various steps required to process a specimen prior to using the Shandon Cytospin. Good laboratory practice requires the use of a biological safety cabinet for all manipulators of cytological specimens. This includes both the loading and unloading steps for the Shandon Cytospin. Once the specimen is loaded into the Shandon Cytospin sealed head, and the lid is sealed in place, the sealed head may then be taken outside the biological safety cabinet for spinning in the Shandon Cytospin. After the Shandon Cytospin has stopped, the sealed head should be returned to the biological safety cabinet prior to being opened.

Due to the potentially infectious nature of the specimens that may be processed in the Shandon Cytospin, the laboratory must establish procedures to ensure that the instrument is routinely disinfected. Suggested methods for cleaning and disinfecting of the Shandon Cytospin and accessories will be found in the Cleaning and Maintenance section of the Operator Guide.

As with all clinical specimens, it is extremely important to maintain specimen identification. For the Shandon Cytospin, this means that the slides on to which a specimen

will be deposited must be adequately labelled with the appropriate specimen identification. The method of labelling must take into account the subsequent procedures that will be used. In general, it would be expected that the label might be subjected to fixation steps and staining procedures. Obviously, a paper label would be inappropriate. Pencil identification on frosted-end glass slides is the most common approach to specimen identification.

The laboratory must also ensure that adequate labelling is maintained for all containers or devices to which the specimen is transferred. In use of the Shandon Cytospin, this may include one or more centrifugation steps, conducted in a standard laboratory centrifuge. Each new container to which the specimen is transferred must be appropriately labelled. In addition, the laboratory must ensure containment of the specimen to eliminate potential hazards to the laboratory personnel. Since most centrifuges do not provide aerosol containment during operation, any intermediate centrifugation steps should be conducted in a biological safety cabinet. At the conclusion of specimen preparation, all intermediate containers, pipettes, etc., should be disposed of in an appropriate biohazard container.

Specimen Preparation

Initial Examination

Cytological examination always begins with a macroscopic examination of the specimen at the time it is submitted to the laboratory. This is a crucial examination, as it provides information that will be used to select processing protocol. The macroscopic examination is most useful in the hands of an experienced technologist. Prior experience with a particular specimen is invaluable in recognising whether a given sample is normal or highly suspect, and whether the specimen will be adequate for cytological examination. However, it is usually impossible to determine if a given sample contains abnormal cells from the macroscopic examination only. A specimen which should normally be clear should not be assumed to be abnormal simply because it is bloody on arrival in the laboratory. Any number of circumstances may produce a different appearance in a specimen during the collection process.

The macroscopic examination cannot be used as a definitive test of the specimen. It does serve to support the eventual diagnostic assessment, but more importantly, it provides the information that will allow the technologist to choose a specimen preparation protocol. A complete macroscopic examination may include:

- 1 Record of specimen origin - precise anatomical site.
- 2 Volume of specimen.
- 3 Gross characteristics.

Gross characteristics describe the physical appearance of the specimen. Important parameters are the colour of the specimen, its viscosity, and whether the specimen is homogeneous or contains solid tissue fragments.

The gross examination will also determine if the specimen is fresh or if it has been fixed prior to delivery to the laboratory. In general, it is preferable if all cytological samples are submitted to the laboratory in the fresh state. However, in many cases, due to transport distances or time constraints, the specimen will be fixed prior to submission. This must be noted during the gross examination, as fixation may affect several of the parameters recorded during the gross examination. Prior fixation may also constrain the subsequent processing of the specimen. Fixation and its effects will be discussed in a subsequent section of this paper.

Determination of Cell Number

Successful operation of the Shandon Cytospin requires knowledge of the number of cells present in the sample. While the experienced technologist will achieve reasonable results by estimating the cell number, less than optimal preparations sometimes result from such estimates. It is highly recommended that all specimens be examined specifically to determine cell numbers. Visual appearance alone is often confusing, since specimen turbidity may be the result of cell debris, suspended lipids, or other non-cellular materials. In such cases, a direct determination of cell number is necessary to ensure proper Shandon Cytospin preparations.

Samples which contain 'average' cells, that is cells with an approximate diameter of ten to twelve microns, produce excellent Shandon Cytospin preparations at cell densities of one million cells (1×10^6) per ml. Specimens containing large cells require lower cell concentrations, and specimens with tiny cells, cell organelles, or bacteria, may require higher concentrations. The absolute concentration required will be somewhat dependent on the processing methodology employed. As a general rule, the concentration chosen should be such that the cells within the sample have adequate space to spread into a monolayer on the slide surface, with minimal overlap, or piling up of cells. Ideally, the concentration should be high enough that there is not too much space between cells. Having sufficient concentration of cells speeds up evaluation of the preparation, since little time will be lost in searching for cells to evaluate.

A quick method for approximating the number of cells present in a sample is to place a single drop of the sample on a slide and cover with a 24 x 50 mm coverslip. By lowering the condenser of the microscope, or by closing the microscope condenser diaphragm, the unstained cells can be seen (although detail will not be seen). Using the 10 x objective, scan the field and pick an area that appears about average for the entire slide. The cells will mostly likely not be evenly spread, which is why it is necessary to select an average area. Now switch to the 40 x objective. You may also need to open the diaphragm or raise the condenser slightly.

Methodology Guidelines

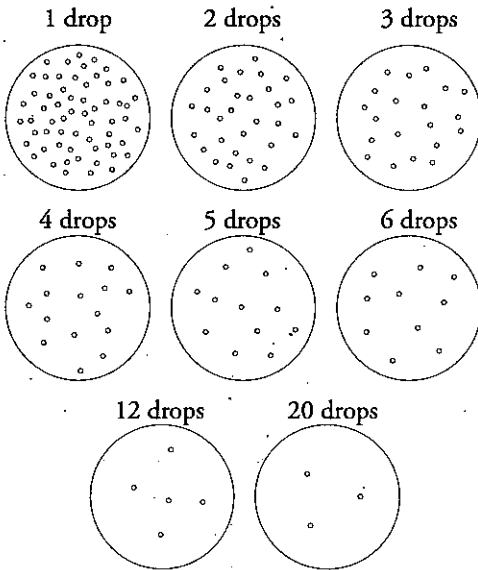

The large circles represent cells in one drop of cell suspension, either of unprocessed cell specimen or preferably of centrifuged cell concentrate, that have been spread under a 24 x 50 mm cover glass and viewed under a 40x objective. Although drawn smaller than they appear microscopically, the cell and field diameters are proportional to one another at a 50:1 ratio. Simply match the microscopic field with its closest counterpart here and use the number of drops so indicated.

Cells / 40x field as a guideline to the number of drops of cell suspension / Shandon Cytospin sample chamber

Count the cells seen in the field. It is not necessary to count every cell - an approximation will do. Refer to the illustration *Cells / 40x field as a guideline to the number of drops of cell suspension / Shandon Cytospin sample chamber*. This count can be used to estimate the number of drops of the cell suspension required for a Shandon Cytospin preparation. To determine the number of cells being used, multiply the number of cells counted by 38. Divide the number of cells counted into 60. The quotient equals the number of drops that should be added to the Shandon Cytospin sample chamber, though the total volume should not exceed the 0.5 ml capacity of the chamber. This gives the total number of cells applied to the Shandon Cytospin funnel for each drop of suspension used. While this technique for estimation of cell number is an approximation only, it does provide an excellent control of Shandon Cytospin preparations.

A second method of cell number determination is by manual counting of cells in a haemocytometer. This is a device that defines a precise volume between a special glass slide and a coverslip. By counting the total number of cells within this volume, the cell concentration within the specimen can be accurately determined. While more accurate than simply using a coverslip on a standard slide, the extra precision of this method is not usually required for successful Shandon Cytospin preparations.

A third method for determination of cell number is by use of a cell counter of the electronic volume sensing type (Coulter counter). This instrument can provide a precise evaluation of a cell sample. It does require sufficient amount of sample however, which may not always be available. It is common to determine the cell number of specimens using this instrumentation in the haematology laboratory. Any specimen obtained from the haematology laboratory may include cell number (or concentration) information.

It is important to recognise that samples that are quite concentrated should be handled carefully. For example, if the specimen is so concentrated that only a single drop may be required, the addition of a second drop will double the cell concentration. It is preferable to work with specimens that are dilute enough that five or six drops are required for the preparation. With such a specimen, the addition of one more drop will not be as likely to result in overlapping cells in the final Shandon Cytospin preparation.

While it is common to discuss sample sizes in terms of 'drops', it is important to realise that drop size will be dependent on the type of pipette used to transfer the specimen. As an example, a Falcon 3 ml transfer pipette will dispense approximately 0.5 ml in 15 drops. A six inch glass Pasteur pipette will dispense 0.5 ml in 20 drops. It is advisable to standardise on a single pipette type for all cytological preparations, otherwise 'drops' will be a meaningless measurement.

Specimen Enrichment

Many cytological specimens arrive in the laboratory as relatively large fluid volumes, many with relatively few cells. Such specimens must obviously be concentrated prior to use of the Shandon Cytospin. Such concentration requires the use of a general laboratory centrifuge. The amount of the specimen submitted will determine the size centrifuge tubes that will be necessary. In some cases, the original specimen may need to be split between many tubes. As an example, if a centrifuge is available which can hold 50 ml tubes, and the total amount of specimen is 100 ml or less, then two tubes can concentrate the entire specimen. Should the specimen amount to 150 ml, then four tubes would be required. By adding more tubes it is possible to concentrate specimens which are quite large in volume. To sediment the cells, the centrifuge should be spun at 2000 to 3000 rpm for 10 to 20 minutes. Avoid spinning at excessive speeds. This will only damage cells, and pack them into such tight buttons they will be difficult to process further. Centrifuges with swinging buckets will generally require slightly higher speeds than angle headed centrifuges.

After conventional centrifugation, any cells present in the sample would appear as a packed button in the bottom of the tube. The clear supernatant above the cell button should be carefully aspirated or poured off, leaving a volume of fluid approximately equal to the volume of the packed cell button.

The fluid that is aspirated or poured off may be discarded, using any common technique to render it harmless (sterilisation, fixation etc). This fluid should only be discarded after it is determined that the cells within have indeed been retained.

The packed cell button in the bottom of the centrifuge tube should be thoroughly mixed with the residual fluid that was not removed. This is done either by use of a vortex mixer, or by gentle agitation of the tube. The result is a concentrated cell suspension, suitable for cell number determination, and subsequent preparation with the Shandon Cytospin.

Specimen Dilution

Cytology specimens often are submitted to the laboratory with a cell concentration that is too high for Shandon Cytospin preparations until diluted. Such specimens are common from bone marrow, lymphoid aspirates, and many fine needle aspirates. These concentrated specimens should first be evaluated for cell number, using any of the previously described techniques. The specimen should then be diluted to an approximate cell concentration by addition of a balanced electrolyte solution. It is important to use a fluid that has a proper osmolarity, in order not to introduce structural changes in the cell sample. Simple solutions of Sodium Chloride (0.9% saline) are unsuitable as diluents - they produce rapid changes in nuclear chromatin and interfere with subsequent cytological evaluation.

Many of the solutions commonly used in tissue culture laboratories are suitable diluents, such as Earle's balanced salt solution, or Hank's balanced salt solution. In many cases, if the cell suspension submitted to the laboratory has been collected in one of these diluents, or has undergone significant processing in such salt solutions, it may be advisable to add some protein to the diluent. Either human serum or a solution of bovine serum albumin may be used. The usual concentration of these solutions is 1 to 30 percent. The protein solutions of very high concentration are usually used by dropwise addition to the sample just prior to or during loading of the Shandon Cytospin funnels.

Loading the Shandon Cytospin Sample Chambers

The sample chambers hold a maximum of 0.5 ml of specimen and should hold no less than 0.1 ml. Do not place more than 0.5 ml of sample in each standard EZ Cytofunnel sample chamber (up to 6ml for EZ Megafunnels). - Additional sample would simply be thrown to the top of the chamber during Shandon Cytospin operation, and could not be deposited on the slide. It is recommended that the sample chambers are loaded after they have been assembled and inserted into the sealed head. The design of the chamber assemblies and the sealed head ensures that the sample chambers tilt in such a manner that the specimen will not contact the slide or the filter card prior to starting the Shandon Cytospin. The specimen must never contact the slide or filter before the Shandon Cytospin is started.

The operator must be careful during loading not to forcibly inject the sample into the sample chamber. The sample should be eased into the sample chamber slowly, allowing ample opportunity for air to be displaced by the sample.

For concentrated cell suspensions which require only one or two drops of sample to obtain the correct cell concentration, it may be sometimes necessary to add additional diluent to bring the total volume in the sample chamber up to 0.5 ml. This addition can be done in the chamber as the samples are loaded. However, this requires care to avoid forcing sample into the slide / filter area and it is recommended that 'thick' specimens are diluted prior to being loaded into the Shandon Cytospin.

During loading of the sample chamber, the sample should be deposited directly in the bottom of the sample chamber. Avoid dripping the sample down the side of the sample chamber. Should sample be deposited on the walls of the chamber, rinse down with a drop of diluent. The object is to ensure that the entire sample is in the bottom of the sample chamber.

Selecting Time, Speed and Acceleration

The speed of operation of the Shandon Cytospin is dependent on the size of the cells or particles to be deposited on the slides. In general, average cellular specimens will require a speed of approximately 1000 rpm with medium acceleration. Very large cells or fragile cells may require a slower speed, such as 500 to 800 rpm with low acceleration. Specimens consisting of tiny objects such as bacteria may require much higher speeds, approaching 2000 rpm with high acceleration.

Time of Shandon Cytospin operation is also related to specimen type and to subsequent preparative steps. For most cytological preparations, it is desirable to avoid any possibility of air drying of the specimen. Therefore the time used for Shandon Cytospin operation is kept as short as possible, such as 3 to 4 minutes. For haematology and microbiology specimens that often are air dried prior to further processing, a longer time is used, often approaching ten minutes.

An appropriate Shandon Cytospin time will ensure fluid absorption. The cells on the slide should have a thin layer of fluid on their surfaces. Occasional specimens may be too thick to completely absorb in the filter paper during a normal time and speed setting. Such specimens may require special processing. An example is joint aspirations that contain hyaluronic acid, giving them a thick consistency. This can be reduced by adding a small amount of the enzyme hyaluronidase to the sample prior to operation of the cytocentrifuge.

Unloading the Sample Chambers

After the Shandon Cytospin stops, the specimens should be removed as quickly as possible. The lid of the Shandon Cytospin is opened, and the sealed head is removed and taken to the biological safety cabinet. The lid is opened, and the individual sample chamber assemblies are removed from the sealed head. The thumb pad release lever is pressed to open the slide support. The slide should be held horizontally on occasions where liquid remains, allowing any residual fluid to flood the slide. If there is a considerable amount of residual fluid, wait until some of it evaporates. However, do not allow the specimen to dry. Just before drying begins, place the slide in fixative, or spray with Shandon Cell-Fixx.

For specimens that do not contain excess fluid, quickly remove the sample chamber, remove the slide, and immediately place into fixative. (This is best achieved by easing the slide into the fixative, so as not to disturb the deposited cells).

Evaluation of Specimen to Assess Technique

After staining, the specimens can be evaluated to assess the preparative technique.

The ideal result is a monolayer of cells with minimal overlap, yet sufficiently concentrated that one does not have to search for cells in the preparation. The cells should display excellent morphology. There should be no evidence of stretching, or tearing of the periphery of cells. Such artefacts indicate excessive speeds or times of cytocentrifugation. In excellent preparations, there will be flattened nuclei with distinct chromatin patterns. Some cell types, such as columnar epithelial cells should retain their typical columnar

morphology. Distortion of their columnar shape indicates excessive speed or time of cytocentrifugation.

Occasionally one will see a specimen that has a pattern of cell deposition around the periphery of the deposition spot, with a loss of cells in the centre. This effect is due to an excess amount of residual fluid in the centre of the cell deposition area when the specimen is fixed. Because the cells in the centre of the area are quite wet, they wash off the slide as it is immersed into the fixative. The solution to this problem is to allow longer time for the slide to dry prior to fixation, and to be exceptionally gentle during immersion of the slide into the fixative.

Fixation

Fixation is used to preserve cell samples, to render them more easily stained, and to produce characteristic patterns of cell structure that are used to distinguish cell types. Cells continue their natural living processes after being removed from body sites. Since they no longer have their normal blood supply and other supporting environment, they will begin to degenerate as they run out of required nutrients and gases and begin to build up waste products. As these events continue, the cell activates internal repair mechanisms that eventually result in the cell digesting itself. This is called autolysis. The rate at which autolysis progresses is different for different cell types, but does mean that samples should be processed as quickly as possible. Autolysis can be slowed significantly by refrigeration, and samples may be held for some period of time at refrigerator temperature. Where practical however, specimens should be fixed or processed as soon as possible.

Fixatives are chemical agents that both kill the cell and stabilise its structure. The 'killing' also inactivates many of the enzyme systems of the cell, particularly those associated with autolysis. Fixatives therefore also function as preservatives, and well-fixed cytological samples essentially last indefinitely. Many specific chemicals can be used as fixatives, and each has specific properties that are desirable for certain types of study. These fixatives include those that produce chemical cross-links within the tissues, such as formalin, and those that precipitate cellular components

such as the alcohols. By far the most common fixative used in cytological studies is alcohol. Alcohol produces distinct nuclear chromatin patterns, and also serves to remove water from the cells. Shandon Cell-Fixx spray fixative is an example of an alcohol based cytological fixative which also contains Carbowax.

A disadvantage of alcohol fixatives is that they evaporate quickly, and therefore there is always the risk of permitting specimens to dry out. To avoid this, many laboratories use Saccomanno fixative, which is a mixture of 70% ethyl alcohol and 2% Carbowax (polyethylene glycol). The Carbowax in this mixture forms a coating over the specimen, helping protect from the effects of drying. The Carbowax is soluble in water, and so is dissolved in subsequent staining steps. Commercial versions of this fixative are available (for example Shandon Cytospin Collection Fluid).

When specimens must be transported over considerable distances, or when they cannot be processed immediately, it is advisable to fix with alcohol or with Saccomanno type fixative. This is done by adding an equal volume of fixative to the sample. If the specimen is large in volume, the sample should be centrifuged to concentrate the cells, and then fixed. Immediately after adding the fixative to the sample, the sample should be vigorously agitated to suspend the sample within the fixative.

Occasionally samples will be received that have been fixed in some other fixative such as formalin. These will have a different nuclear and cytoplasmic appearance if processed without exposure to alcohol. Such specimens can be concentrated, the formalin poured off, and then re-suspended in Shandon Cytospin Collection Fluid. The result will be a specimen that is reasonably similar to those fixed in the alcohol fixative alone.

Fixation makes cells more rigid and less able to spread when placed in the Shandon Cytospin. Specimens that have been fixed prior to depositing on slides will require slightly higher speeds and longer times to achieve the same degree of spreading as seen in unfixed specimens. Occasionally

the laboratory will be asked to prepare specimens that have been held in fixative solutions for extended times. These specimens may be so rigid that it is difficult to get them to flatten on the slide. The addition of a small amount of glycerol to the specimen, allowing some 'soak' time, followed by use of the Shandon Cytospin, will usually result in a reasonable preparation.

Many laboratories prefer to fix all specimens during preparation. The usual protocol is to concentrate the specimen, then re-suspend in an equal volume of Shandon Cytospin Collection Fluid. For samples that must be diluted, the diluent can be fixative. These fixation steps are generally done just before adding the sample to the Shandon Cytospin sample chamber assemblies.

Whether the specimen has been fixed before deposition on slides or not, immediately after removing the slides from the Shandon Cytospin, they should be immersed in 95% alcohol to complete fixation and dehydration. Since the cells will still be wet, and will not have become totally bound to the glass slide, use care in this transfer. (Ease the slide into the fixative in the container). Many complaints of poor cell capture can be traced to lack of care in this step of the procedure.

Special Considerations

Cell Adhesion

Successful application of the Shandon Cytospin requires that cells adhere to the glass slides. For many routine applications, it is sufficient to use clean slides. Slides may be cleaned using alcohol. The increasing use of long staining techniques, such as immunostaining, may require additional ways to ensure adhesion of samples. The use of coated slides will increase cell retention and reduce the incidence of 'floaters' in the subsequent staining baths.

Cytology

The majority of the procedures previously discussed apply to cytological specimens. However, there are a number of specific specimen types that require special processing. Often, the cytology specimen will contain clots, fibrin webs, or tissue fragments. These will all interfere with the Shandon

Cytospin preparations. Small floating clots and fragments should be removed with forceps. These may be saved for cell block procedures. Fibrin webs are generally too friable to be removed intact. These are most easily removed by twirling a glass or wooden rod in the specimen. The fibrin web is wound onto the rod, and in the process, many of the trapped cells will float free. After winding on the fibrin, it is pressed gently against the side of the container to squeeze out as much of the trapped fluid and cells as possible. As with all cell manipulation techniques, it is important to be gentle to avoid excessive cell damage.

Cytological samples may contain considerable quantities of mucus. This a very thick mass that is difficult to dilute or concentrate, and becomes a rubbery mass on fixation. Such specimens should be processed prior to fixation. A common way to break up mucus is to mix with an equal part of Saccomanno-type fixative (for example Shandon Cytospin Collection Fluid) and immediately blend in a small blender. Three to five seconds is usually sufficient. The blending procedure should be done in a biological safety cabinet. After blending, the sample should be homogenous and non-stringy, and can be deposited using the Shandon Cytospin. Certain chemicals also react with mucus to produce liquefaction, such as acetylcysteine (Boccatto, 1981). A commercial product of this type is Shandon Mucolox, which contains not only a mucolytic agent but Saccomanno-type fixative as well.

Bloody or serosanguineous specimens may contain so many erythrocytes that examination of cytological preparations is difficult, and when the specimen is diluted sufficiently to obtain monolayer preparations, the cells of interest are difficult to locate. Red blood cells may be removed by gradient centrifugation or by various lysing procedures. Lysing techniques are commonly used for leukocyte counting on cell counters that employ sensing orifices. CytoRich Red collection fluid completely destroys erythrocytes. The large amounts of haemoglobin released from the red cells may interfere with subsequent staining. It can be removed by several washing steps using a conventional centrifuge.

Gradient centrifugation is based on a density difference between red cells and other cells within a specimen. Commercial gradients are available, and are based on mixtures of Ficoll and Hypaque. The sample is layered onto the gradient in a centrifuge tube and then the tube is centrifuged. The red cells will migrate through the gradient, and will also be haemolyzed. The remaining cells will stay on top of the gradient, and can be removed for subsequent processing.

Haematology

The primary difference between cytological and haematological preparations is the routine use of air dried preparations in haematology. In most cases, haematology will also have available a specific cell count derived from an electronic volume sensing instrument. This permits a defined solution and allows precise control of cell number on the final Shandon Cytospin preparation.

Haematological samples are routinely diluted to obtain samples of the correct cell concentration. The diluent used is commonly one of the balanced salt solutions. Thermo recommend that coated slides are used to increase adhesion of the cells to the slide, and to avoid the deleterious effects of the high concentration as the diluent evaporates during the drying of the slide.

Since haematology specimens are to be air dried, they should not be flooded with any residual liquid after use of the Shandon Cytospin. For haematology, after the chambers are removed from the Shandon Cytospin sealed head, any residual fluid is allowed to drain back into the sample chamber. The thumb pad release lever is then pressed to open the slide support and remove the slide. The disposable cytochamber is properly discarded following laboratory safety procedures. The slide is then air dried. As with all air dried preparations, the more rapidly drying occurs, the better. Drying may be accelerated by gentle heating of the slides.

Urine Specimens

Specimens derived from urine are typically high volume fluids with few cells or particles. These specimens must be concentrated by conventional centrifugation prior to cytological examination. If appropriate, a Shandon EZ Megafunnel can be used. Often urine samples contain particles that are not cellular but are precipitated phosphate salts. It is often suggested that one can dissolve these particles by acidifying the specimen with a few drops of acetic acid. While this will cause the salts to dissolve, acetic acid is also a classic fixative. It will cause chromatin condensation in the cell nuclei, and will also produce significant cell swelling. Acetic acid is a component of Carnoy's fixative. If acetic acid is used, its effects must be accounted for in subsequent evaluation of the specimen.

Microbiology

Many microbiology samples are quite similar to cytological samples. They will contain cells and the microbiologist is interested in the association of bacteria or viruses with the cells. The Shandon Cytospin can also be used to directly deposit samples of bacteria onto slides. The advantages of this use is that the deposited bacteria are generally more concentrated than after simple smearing, and they are all located in a defined area of the slide. Due to the small size of the bacteria, the Shandon Cytospin is generally operated at speeds of 2000 rpm for five to ten minutes with high acceleration.

Many of the techniques used for localisation of viruses or bacteria require the use of fixatives other than alcohol-based ones. In general, techniques using immunostaining or nucleic acid probes will specify the use of aldehyde fixation, such as formaldehyde (paraformaldehyde) or glutaraldehyde. These do not affect the operation of the Shandon Cytospin, since they are applied to the slide after the cells, bacteria, or viruses are deposited on the slide. It is important to use a slide adhesive or preferably coated slides for these preparations.

The Use Of The Shandon Cytospin For Haematology And Other Clinical Microscopy Specimens

These guidelines outlining the Use of the Shandon Cytospin for Haematology and other Clinical Microscopy Specimens have been prepared by:

Nicky Sherwood, MT (ASCP) and Joanne Cornbleet (MD),
Clinical Haematology Laboratory,
Stanford University Medical Centre

Introduction

This section is designed to provide general guidelines for the use of the Shandon Cytospin in haematology and clinical microscopy.

Uses and Applications

The Shandon Cytospin has a wide range of applications in clinical microscopy, some of which are shown below.

Table 1 Uses and Applications

Uses	Clinical Applications
Romanowsky-stained cytology of CSF and other body fluids	Evaluation of possible infection or presence of malignancy
Gram stain and other special stains of CSF and body fluids	Detection of infectious agents - characterization of malignant cells
Slide preparation from ficoll-hypaque cell isolates	Provides slides for morphology, cytochemical staining (e.g. myeloperoxidase, non-specific esterase), and immunocytochemical or immunofluorescent assays (e.g. TdT). Used to characterize leukemias and lymphomas
Cell surface and cytoplasmic marker studies using monoclonal antibodies	Classification of leukemias and lymphomas
Urine eosinophils	Evaluation of drug-induced nephritis, allergic cystitis, and renal transplant rejection
Urine hemosiderin	Confirmation of severe intravascular hemolysis and chronic iron overload

Methodology Guidelines

When first setting up the Shandon Cytospin for use, it is helpful to establish a standard procedure, i.e. the amount of specimen per slide, rpm and minutes centrifuged, and maximum number of white blood cells per litre and red blood cells per litre, above which dilutions would be necessary.

- 1 Determine the red cell and white cell count of the sample according to established methods.
- 2 Using a 'standard' amount of specimen, (e.g. 5 drops or approximately 0.25 ml) make serial dilutions of a highly cellular specimen to determine the maximum number of white blood cells and red blood cells that can be present in a specimen before dilutions are necessary. Some tests may require more cellular slides than others.
- 3 Experiment with a range of speeds to see which gives the most desirable morphology for the procedure involved. Establish the minimum number of minutes required to spin the entire standard amount of specimen onto the slide.
- 4 The following is an example of a standard procedure for preparing slides for a white cell differential with Wright stain:

Use 5 drops of specimen per Shandon Cytospin chamber. Dilute sample to obtain a white cell count less than $0.5 \times 10^9 / l$ and a red cell count less than $0.005 \times 10^{12} / l$. Centrifuge at 700 rpm for 5 minutes with medium acceleration.

Table 2 Dilution Chart for WBC Dilution

WBC Count (x 10 ⁹ /litre)	Dilution
0 - 0.05	None
0.05 - 0.1	1/2
0.1 - 0.15	1/3
0.15 - 0.2	1/4
0.2 - 0.25	1/5
0.25 - 0.3	1/6

If the red cell count which results from the above WBC dilution is greater than $0.005 \times 10^{12} / l$, calculate the further dilution necessary to bring the red cell count below $0.005 \times 10^{12} / l$. Use this dilution regardless of the fact that the white cell count may be very low.

- 5 Use a disposable EZ Single Cytofunnel.
- 6 Always place the EZ Cytofunnel assembly into the Shandon Cytospin head before adding anything to the sample chamber. Check that the assembly pivots freely in the metal support plate.
- 7 Use coated slides to increase the adhesion of the cells to the slides. Cap the sample chambers.
- 8 Lock the lid onto the sealed head, transfer the sealed head to the Shandon Cytospin, and close the lid. Never snap the lid of the Shandon Cytospin head down onto the bowl while the assembly is sitting on the drive shaft, as this may damage the shaft.
- 9 Program the Shandon Cytospin to the standard number of rpm and minutes and start the unit. Fragile cells may require a lower rpm setting and low acceleration to maintain morphology.

- 10 When the 'End of Run' tune has ended, remove the sealed head and transfer it to a hood before opening.
- 11 Check the sample chambers to see if all of the specimen has spun onto the slide. Make sure that any remaining specimen in the chamber does not flow onto the slide as it is removed from the assembly. Should this occur, the cells will not remain spread out on the slide and may therefore overstain.

**Suggestions for
Optimal Shandon
Cytospin Technique**

- 1 Use coated slides.
- 2 Do not make a push smear, even when the cell counts are high. Large malignant cells are difficult to identify on push smears because they may aggregate at the feather edge or stain darkly in the thick portion of the smear.
- 3 Use a disposable EZ Cytofunnel and do not let unspun specimen wet the slide.
- 4 If fibrin strands or other contaminated materials are present, they may clog the filter card and prevent absorption of the specimen. Better slides may sometimes be obtained if an aliquot of the specimen is first diluted in saline, centrifuged, and then the cells are re-suspended in saline to the original volume.
- 5 If synovial fluid is extremely viscous, a small amount of hyaluronidase may be added to liquefy the sample before processing.
- 6 If a fluid is clotted, Shandon Cytospin slides may be prepared from a suspension of the clotted material as well as from the unclotted fluid to increase the possibility of detecting malignant cells.

Appendix C Transportation Instructions

If you ever need to transport the Shandon Cytospin 4 cytocentrifuge, the following packaging instructions should be followed.

Repacking

Note If the Shandon Cytospin 4 (and sealed head) is to be serviced or returned to Thermo, they must be thoroughly cleaned and decontaminated, and the Product Return Safety Declaration signed (see page 111). ▲

Press the O (OFF) side of the mains power switch to switch the mains power switch off.

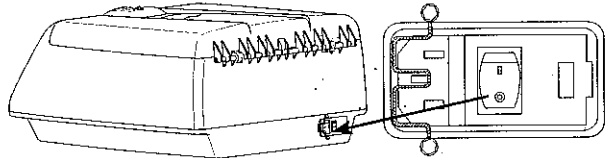

Disconnect the mains cable from the mains supply and the Power Supply Unit.

Place the sealed head into the instrument and fit the circular foam packing piece onto the top of the sealed head lid. Close the Shandon Cytospin lid. Make sure that the lid is secure.

Transportation Instructions

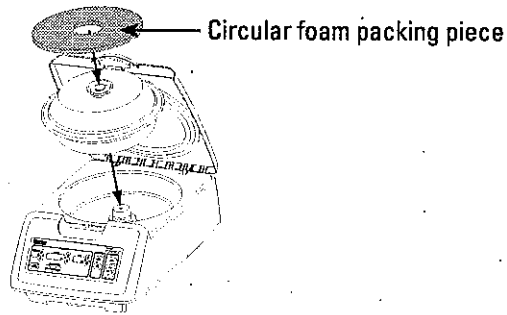

Place the Operator Guide into the packing box and place the instrument on top of it.

Lay the 'H' shaped packing strip onto the instrument and the four cardboard strengthening pieces on top.

Put the mains lead with the pen and manual release tool into the smaller box and place this box in the front of the main box.

Close and seal the box.

Cardboard strengthening pieces

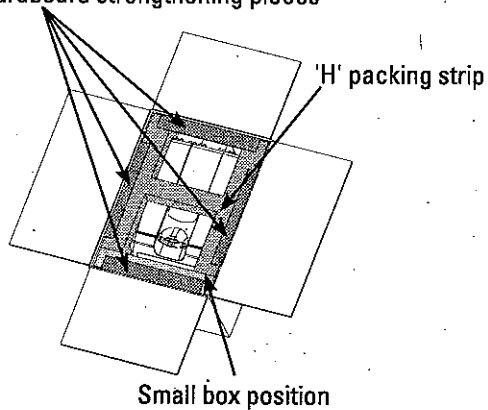

PRODUCT RETURN SAFETY DECLARATION

Part 1 DECONTAMINATION CERTIFICATE

Any instrument or part of any instrument must be clean before being returned, and where necessary accompanied by a completed Decontamination Certificate. Should the instrument or any part of it be received in an unclean condition, or Thermo Electron Corporation consider it to be a hazard, the instrument or part will be returned unrepaired at the expense of the customer.

It is important that the certificate is forwarded by post or fax, and a copy attached to the exterior of the container. Containers will not be opened until the company is in possession of the required certificate. This form **MUST** be completed by the customer and **NOT** a Thermo or distributor employee.

If the instrument or any part of it is to be returned to Thermo and has been exposed to, or been in contact with potential pathogenic or radioactive material, it is essential that it is decontaminated.

Set procedures are laid down in the European Health and Safety Directives for decontamination. To avoid any misunderstanding, we request that all instruments or parts returned to us must be accompanied by a certificate stating the following:

We certify that the instrument: Model Serial No	<ul style="list-style-type: none"> ● has not been exposed to pathogenic, radioactive or other hazardous material and has been cleaned ● has been exposed to pathogenic, radioactive or other hazardous material and has been decontaminated and cleaned according to approved procedures, following exposure to:
---	--

Has the instrument been used for work with human, or animal, Transmissible Spongiform Encephalopathies, e.g. Creutzfeld-Jacob disease, Scrapie or BSE? If YES, please contact Thermo Service before taking any further action.	YES / NO
---	-----------------

Signed	Signed
Name (Block Capitals)	Company/Organisation
Full address	

Part 2 GUIDELINES FOR RETURNING INSTRUMENTS

Please use the checklist (below left) to ensure that the instrument being returned is ready for collection, then fill in the details (below right).

● All reagents / wax removed from instrument, including vapour traps (if applicable)	RMA NUMBER
● Accessories are secured / itemised	CARRIER
● Instrument has had transit clamps fitted as detailed in the Operator Guide	FOR ATTENTION OF
● Instrument is packed in original packaging

Thermo Electron Corporation, 93-96 Chadwick Road, Astmoor, Runcorn, Cheshire, WA7 1PR, United Kingdom
 Tel: +44 (0) 1928 566611; Fax: +44 (0) 1928 565845; www.thermo.com/shandon.

Product Return Safety Declaration

Appendix D Approved Reagent List

This Section lists all the reagents that Thermo specify can be used with the Shandon Cytospin 4 cytocentrifuge.

If you want to use a reagent not included in this list, contact your Thermo agent for advice.



ALWAYS REFER TO THE MATERIAL SAFETY DATA SHEET (MSDS) FOR THE REAGENTS USED. ▲

Reagent List

- Industrial Methylated Spirits (IMS) / Reagent alcohol (up to 5% methanol in ethanol)
- Isopropyl Alcohol (IPA)
- Ethanol
- Cytospin® Collection Fluid
- Mucolexx® Transport Fluid
- CytoRich® Red Collection Fluid
- Formal-fixx™
- Cytoblock® reagents

Cleaning Agents

- General purpose household or commercial detergent (diluted in accordance with the manufacturer's instructions)
- Sodium Hypochlorite 10% (10% commercial bleach)
- Most proprietary disinfectants in common laboratory use, such as Clorox®, or commercial disinfectants diluted with 0.3% bicarbonate buffer at 7.0 to 8.0 pH, should be suitable (always test a small hidden area of the instrument case first).
- Water

WARNING

Do not use xylene, toluene or similar solvent. ▲

WARNING

Do not use detergents that are unsuitable for use on non-ferrous metals (for example Decon 90) on the sealed head assembly. ▲

Approved Reagent List

Index

Symbols

 biohazard symbol 4

 warning symbol 4

 warning symbol 4

A

annotated diagram 9

Approved Reagent List 113

cleaning agents 113

reagent list 113

B

biohazard symbol explanations 4

biosafety seals

safety warning 6

C

chemically reactive materials - warning 6

cleaning agents, approved 113

Cleaning and Maintenance 51

recommended materials 53

routine cleaning and maintenance 54

front panel 55

lid, case, plinth and bowl liner 55

sealed head assembly 56

sealed head base 57

sealed head lid 59

support plate 58

seal replacement 60

cone seal 60

sealed head lid seal 61

sealed head O-ring seal 61

contact addresses 2

Contents 3

Controls 27

main control panel 27

control keypad 31

standby 32

start 31

stop 32

program keypad 27

'end of run' warning 30

acceleration 30

program 28

save program 30

speed 28

time 29

status display 32

lid locked 33

lid open 33

control keypad 31

standby 32

start 31

stop 32

Cytofunnels 20

EZ double 21

maximum run time 22, 46

maximum volume 21

EZ mega 23

maximum speed 25, 47

maximum volumes 23

EZ single 20

brown filter card (low absorbency) 21

maximum run time 21

Index

- maximum volumes, 21
- white filter card (high absorbency) 21
- maximum volumes 21, 23, 43

D

- Declaration of Conformity 83
- depth 11
- Description 9
 - overview 9
 - annotated diagram 9
- dimensions
 - depth 11
 - height 11
 - width 11

E

- earthing requirements 6, 18
- emergency release 14
- Error Codes 65–66
- explosive materials - warning, 6
- EZ Cytofunnels 20
 - double 21
 - maximum run time 22, 46
 - maximum volumes 21
 - maximum volumes 43
 - mega 23
 - maximum speed 25, 47
 - maximum volumes 23
 - single 20
 - brown filter cards (low absorbency) 21
 - maximum run time 21
 - maximum volumes 21
 - white filter cards (high absorbency) 21

F

- factory approved accessories 7
- flammable material warning 6

G

- 'g' force table 37

H

- height 11

I

- Index 115
- Installation and Setting Up 11
 - accessories 20
 - Shandon EZ Double Cytofunnel 21
 - Shandon EZ Megafunnel 23
 - Shandon EZ Single Cytofunnel 20
 - dimensions
 - depth 11
 - height 11
 - width 11
 - electrical requirements 16
 - protective earthing requirements 18
 - wiring convention 17
 - lifting instructions 12
 - location requirements 11
 - opening and closing the Cytospin 4 lid 13
 - emergency release 14
 - opening and closing the sealed head 14
 - switching on and off 18
 - switching off 19
 - switching on 18
 - unpacking 12
- intended use of Shandon Cytospin 4 5

L

- lifting instructions 12
- loading and unloading
 - safety considerations 6
- location requirements 11

M

- Methodology Guidelines 87–108

O

- Operation 35
 - 'g' force table 37
 - acceleration settings 48
 - error codes, audible tones and warnings 49
 - loading the disposable Cytofunnels 40
 - loading the sealed head 42
 - loading the Shandon Cytospin 4 40
 - running the Shandon Cytospin 4 38
 - saving a program 45
 - selecting a program 44
 - speed settings 46
 - starting a run 48
 - time settings 46
 - unloading the Shandon Cytospin 4 49

P

- Product Return Safety Declaration 111
 - requirement 7
- program keypad 27
- 'end of run' warning 30
- acceleration 30
- program 28
- save program 30

- speed 28
- time 29



R

- reagents, non-approved 113
- reagent list, approved 113
- repacking 109

S

- safety warnings 5
- sealed head
 - opening and closing 14
- seal replacement
 - cone seal 60
 - sealed head lid seal 62
 - sealed head O-ring seal 61
- Shandon EZ Double Cytofunnel 21
- Shandon EZ Megafunnel 23
- Shandon EZ Single Cytofunnel 20
- Specification and Accessories 75
 - accessories and spares 77
 - centrifuge accessories 77
 - centrifuge spares 77
 - general spares 79
 - other accessories 77
 - specification 75
 - electrical 75
 - power supply voltages 75
 - environment 76
 - altitude 76
 - general 76
 - humidity 76
 - operating temperature 76
 - over voltage category 76

Index

- pollution degree 76
- transit/storage temperature 76
- fuses 75
- part numbers 76
- physical 75
 - depth 75
 - height 75
 - weight 75
 - width 75
- program details 75
- sound power levels 75
- switch convention 75
- Standard Workflow Diagram 85
- status display 32
 - lid locked 33
 - lid open 33
- symbol explanations 4
 -  biohazard symbol 4
 -  warning symbol 1 4
 -  warning symbol 2 4

T

- toluene warning 113
- Transportation Instructions 109
 - Product Return Safety Declaration 111
 - repacking 109
- Troubleshooting 63
 - Table 1 - Instrument Function 64
 - Table 2 - Error Codes 65-66
 - T - Quantity 69-71
 - Table 5 - Unusual Pattern of Cell Population Distribution 72
 - Table 6 - Summary 73

U

- unloading and loading
 - safety considerations 6
- unpacking 12

W

- warning symbol explanations 4
- Warranty Statement 81
- weight 6
- Welcome 5
 - safety warnings 5-7
- width 11
- wiring convention 17

X

- xylene warning 113

Contact Addresses

Clinical Diagnostics
Anatomical Pathology
93-96 Chadwick Road
Astmoor, Runcorn
Cheshire, WA7 1PR, UK

Tel: +44 (0) 1928 566611

Fax: +44 (0) 1928 565845
www.thermo.com/shandon

Clinical Diagnostics
Anatomical Pathology
171 Industry Drive
Pittsburgh
PA 15275, USA

Tel: 1-800-547-7429
+1 412 788 1133

Fax: +1 412 788 1138
www.thermo.com/shandon

