

J-Lite® JLA-16.250 Fixed Angle Rotor



**Used In Beckman Coulter J2
and Avanti® J Series Centrifuges**



SAFETY NOTICE

This safety notice summarizes information basic to the safe use of the rotor described in this manual. The international symbol displayed above is a reminder to the user that all safety instructions should be read and understood before operation or maintenance of this equipment is attempted. When you see the symbol on other pages of this publication, pay special attention to the safety information presented. Observance of safety precautions will also help to avoid actions that could damage or adversely affect the performance of the rotor. This rotor was developed, manufactured, and tested for safety and reliability as part of a Beckman Coulter centrifuge/rotor system. Its safety or reliability cannot be assured if used in a non-Beckman Coulter centrifuge or in a Beckman Coulter centrifuge that has been modified without Beckman Coulter's approval.



Handle body fluids with care because they can transmit disease. No known test offers complete assurance that such fluids are free of micro-organisms. Some of the most virulent—Hepatitis (B and C) viruses, HIV (I–V), atypical mycobacteria, and certain systemic fungi—further emphasize the need for aerosol protection. Handle other infectious samples according to good laboratory procedures and methods to prevent spread of disease. Because spills may generate aerosols, observe proper safety precautions for aerosol containment. Do not run toxic, pathogenic, or radioactive materials in this rotor without taking appropriate safety precautions. Biosafe containment should be used when Risk Group II materials (as identified in the *World Health Organization Laboratory Biosafety Manual*) are handled; materials of a higher group require more than one level of protection.



The rotor and accessories are not designed for use with materials capable of developing flammable or explosive vapors. Do not centrifuge such materials in nor handle or store them near the centrifuge.



Although rotor components and accessories made by other manufacturers may fit in the JLA-16.250 rotor, their safety in this rotor cannot be ascertained by Beckman Coulter. Use of other manufacturers' components or accessories in the JLA-16.250 rotor may void the rotor warranty and should be prohibited by your laboratory safety officer. Only the components and accessories listed in this publication should be used in this rotor.



Make sure that filled containers are loaded symmetrically into the rotor and that opposing bottles or tubes are filled to the same level with liquid of the same density.



If disassembly reveals evidence of leakage, you should assume that some fluid escaped the rotor. Apply all appropriate safety and decontamination procedures to the centrifuge and accessories as required.



Never exceed the maximum rated speed of the rotor and labware in use. Refer to the section on RUN SPEEDS.



Do not use sharp tools on the rotor that could cause scratches in the rotor surface. Corrosion begins in scratches and may open fissures in the rotor with continued use.

J-Lite® JLA-16.250 FIXED ANGLE ROTOR

SPECIFICATIONS

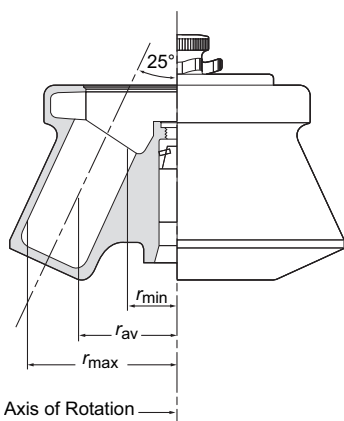

U.S. Patent No. 5,584,790

Maximum speed (Avanti® J series centrifuges)	16 000 rpm
Maximum speed (J2 series centrifuges)	14 000 rpm
Critical speed range*	600 to 800 rpm
Maximum solution density	1.2 g/mL
Relative Centrifugal Field† at maximum speed	
at r_{max} (134 mm)	$38\,400 \times g$
at r_{av} (90 mm)	$25\,800 \times g$
at r_{min} (46 mm)	$13\,200 \times g$
k factor at max. speed in Avanti J series centrifuges.	1090
k factor at max. speed in J2 series centrifuges	1400
Conditions requiring speed reduction	see RUN SPEEDS
Maximum allowable imbalance of opposing loads.	10 grams
Number of bottle cavities	6
Available bottles and tubes	see Table 3
Tube angle	25°
Nominal tube capacity of largest tube.	250 mL
Nominal rotor capacity	1500 mL
Rotor weight, empty	10.3 kg (22.7 lb)
Rotor weight, maximum sample mass	13.2 kg (29.1 lb)
Approximate acceleration time to maximum speed	
(rotor fully loaded)	
in an Avanti J centrifuge (to 16 000 rpm)	3 1/2 min
in a J2 series centrifuge (to 14 000 rpm)	4 1/2 min
Approximate deceleration time from maximum speed	
(rotor fully loaded)	
in an Avanti J centrifuge (from 16 000 rpm)	2 3/4 min
in a J2 series centrifuge (from 14 000 rpm)	4 min
Rotor material	aluminum
Rotor entry code for Avanti J-E centrifuges	16.25
Rotor entry code for	
microprocessor-controlled J2 series centrifuges	14

* The critical speed range is the range of speeds over which the rotor shifts so as to rotate about its center of mass. Passing through the critical speed range is characterized by some vibration.

† Relative Centrifugal Field (RCF) is the ratio of the centrifugal acceleration at a specified radius and speed ($r\omega^2$) to the standard acceleration of gravity (g) according to the following formula:

$$RCF = \frac{r\omega^2}{g}$$

where r is the radius in millimeters, ω is the angular velocity in radians per second (2π RPM / 60), and g is the standard acceleration of gravity (9807 mm/s^2). After substitution:

$$RCF = 1.12 r \left(\frac{\text{RPM}}{1000} \right)^2$$

DESCRIPTION

This rotor has been manufactured in a registered ISO 9001 or 13485 facility for use in Beckman Coulter Avanti® J and J2 series centrifuges.

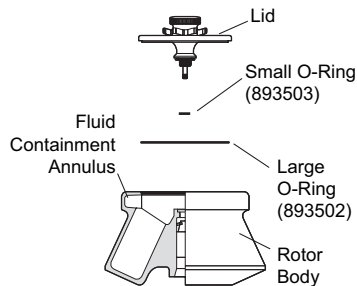

The J-Lite® JLA-16.250 fixed angle rotor (see Figure 1), rated for 16 000 rpm in Beckman Coulter Avanti J series centrifuges and 14 000 rpm in Beckman Coulter J2 series centrifuges, is designed to hold up to six 250-mL bottles at a 25-degree angle to the axis of rotation. The JLA-16.250 rotor develops centrifugal forces that can efficiently pellet cells from large volumes, or cell particles from tissue homogenates. Short column methods (such as partially filled tubes) may also be used to purify large quantities of virus in a cushion gradient.

The rotor and lid are made of aluminum and are anodized for corrosion resistance—the rotor is black and the lid is blue. The tie-down knob in the rotor lid secures the rotor to the centrifuge drive hub.

O-rings made of Buna N rubber, located in the rotor lid, help to maintain atmospheric pressure inside the rotor during centrifugation if the O-rings are properly lubricated. Pins in the rotor drive hole mate with grooves in the centrifuge drive hub (older model centrifuges), or with drive hub teeth (newer model centrifuges), to prevent the rotor from slipping during acceleration and deceleration.



Figure 1. The JLA-16.250 Fixed Angle Rotor (dual-locking lid shown)

The dual-locking lid assembly allows the rotor to be loaded into and removed from the centrifuge with the lid secured. The rotor may be placed under a safety hood before the lid is secured or removed. The JLA-16.250 rotor with dual-locking lid was tested¹ to demonstrate containment of microbiological aerosols under normal operating conditions of the associated Beckman Coulter centrifuge, when used and maintained as instructed. The rotor is also available with a single-locking lid.

The JLA-16.250 rotor has a patented fluid-containment annulus, located below the O-ring sealing surface. This feature helps to prevent the escape of liquid into the centrifuge chamber if tubes or bottles leak during centrifugation.

The JLA-16.250 rotor is warranted for 7 years (see the WARRANTY).

PREPARATION AND USE

Specific information about the JLA-16.250 rotor is given here. Use the Rotors and Tubes for J Series Centrifuges manual (publication JR-IM), and the centrifuge instruction manual along with this manual for complete rotor and accessory information.

NOTE

Although rotor components and accessories made by other manufacturers may fit in the JLA-16.250 rotor, their safety in this rotor cannot be ascertained by Beckman Coulter. Use of other manufacturers' components in the JLA-16.250 rotor may void the rotor warranty and should be prohibited by your laboratory safety officer. Only the components and accessories listed in this publication should be used in this rotor.

¹ Validation of microbiological containment was done at an independent third-party testing facility (CAMR, Porton Down, UK, or USAMRIID, Ft. Detrick, MD, U.S.A.). Improper use or maintenance may affect seal integrity and thus containment.

PRERUN SAFETY CHECKS



Read the SAFETY NOTICE at the front of this manual before using the rotor.

1. Make sure that the rotor, lid, and all tubes or bottles and accessories are clean and show no signs of corrosion or cracking.
2. Inspect the rotor drive pins to ensure that they are not damaged (see instructions on page 19). If the drive pins appear to be damaged, contact Beckman Coulter Field Service.
3. Verify that the bottles or tubes being used are listed in Table 3.
4. Check the chemical compatibilities of all materials used. (Refer to Appendix A in *Rotors and Tubes*, or *Chemical Resistances*, publication IN-175).

ROTOR PREPARATION

For runs at other than room temperature, refrigerate or warm the rotor before the run for fast equilibration.

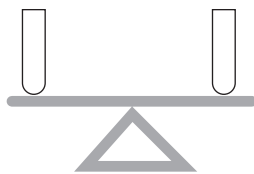

1. Be sure that the metal threads in the rotor are clean and lightly lubricated with Spinkote™ lubricant (306812). Also ensure that lid O-rings are lightly but evenly coated with silicone vacuum grease (335148).
2. Load filled containers symmetrically into the rotor. (Refer to BOTTLES AND TUBES on page 14 for information about containers.) If fewer than six bottles or tubes are being run, they must be arranged symmetrically in the rotor (see Figure 2). Opposing containers must be filled to the same level with liquid of the same density.

OPERATION

- Precool the rotor in the centrifuge or in a refrigerator before use—especially before short runs—to ensure that the rotor reaches the set temperature. A suggested precooling cycle is a minimum of 30 minutes at 2000 rpm at the required temperature.

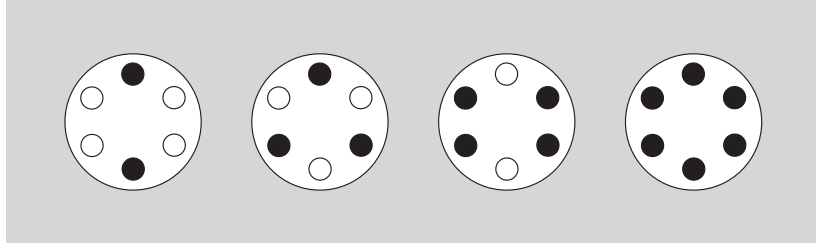

Figure 2. Typical Examples of Arranging Bottles or Tubes in the Rotor. Two, three, four, or six containers can be centrifuged per run, if they are arranged in the rotor as shown.

- If fluid containment is required, use capped bottles or tubes. It is strongly recommended that all containers carrying physiological fluids be capped, and not overfilled, to prevent leakage.
- If you are using an Avanti J series centrifuge, select the JLA-16.250 rotor.
- If you are using a microprocessor-controlled J2 series centrifuge, enter rotor code 14. Refer to your centrifuge instruction manual for additional information. See BEFORE USING THE JLA-16.250 ROTOR IN A MICROPROCESSOR-CONTROLLED J2 SERIES CENTRIFUGE, below, if you are using the rotor for the first time.

BEFORE USING THE JLA-16.250 ROTOR IN A MICROPROCESSOR-CONTROLLED J2 SERIES CENTRIFUGE

If you have a microprocessor-controlled Beckman Coulter J2 series centrifuge (model J2-MI, J2-21M, J2-21M/E, or J2-MC), you will need to enter the JLA-16.250 rotor identification code (14) and maximum speed (14 000 rpm) into the instrument memory *before the first use of the JLA-16.250 rotor in that instrument*. Use the following instructions.

1. On the centrifuge panel, press and hold the [ROTOR] key. While holding [ROTOR], press [PROG SAVE]. Release both keys. The rotor display area will show 1 - - . - . This indicates that you are ready to program the first entry, which is the rotor identification code 14. Enter 14, again press and hold the [ROTOR] key, press [PROG SAVE], and then release both keys.

2. The rotor display should now show 2 -- . -- . You are now ready to program the second entry, the JLA-16.250 rotor's maximum speed in J2 series centrifuges, which is 14 000 rpm. Enter **14**, again press and hold [**ROTOR**], press [**PROG SAVE**], and release both keys.
3. The rotor display should now show 3 -- . -- . The third entry programs the temperature compensation for the rotor. It is not possible, however, to enter a compensation value at this step; you must enter 0. Entering temperature compensation is discussed below (see TEMPERATURE) since it is programmed differently and can be entered only after these three steps have been completed.
4. To complete the entries, press and hold [**ROTOR**], then press [**ENTER/RECALL**], then release both keys. The display should now return to normal.

If you make an error, or if you wish to review the entered information press both [**ROTOR**] and [**PROG SAVE**] repeatedly to cycle through levels 1, 2, and 3. The program can only be logged into memory from level 3, and only when all three entries are complete.

Once this procedure is complete, the microprocessor memory will retain the information and it will not have to be entered again. Each time you run the JLA-16.250 rotor, enter code 14 as described in the centrifuge instruction manual.

INSTALLING THE ROTOR

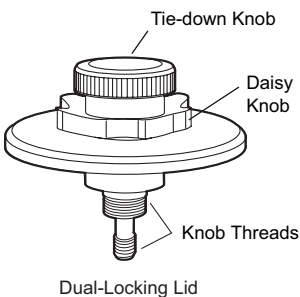

1. To prevent the rotor from sticking to the centrifuge drive hub, apply a thin coat of Spinkote lubricant to the rotor drive pins and to the lid knob threads.
2. Lightly coat the large and small lid O-rings with silicone vacuum grease.
3. *Dual-locking lid only.* Place filled tubes into the rotor, then place the lid on the rotor and turn the daisy knob to the right (clockwise) until secure. Do not overtighten.
4. Two v-shaped indicator marks on either side of the rotor drive hole (see Figure 3) indicate orientation of the rotor drive pins, which are located in the drive hole. To avoid damaging the drive pins as you install the rotor, use the indicator marks to help you align the pins with the centrifuge drive spindle hub.

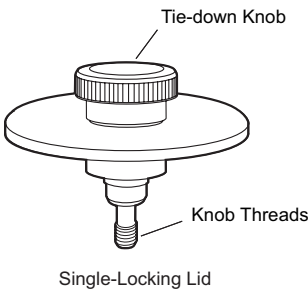

5. Once the rotor is properly aligned carefully lower it straight down onto the hub. *Do not drop the rotor onto the hub.*
6. Slowly turn the rotor around the drive spindle to make sure that it is properly seated. In rare cases, the rotor pins can rest on top of the spindle hub pins or teeth, which prevents the rotor from being secured to the drive spindle. Turning the rotor after installing it will move the pins into proper position.

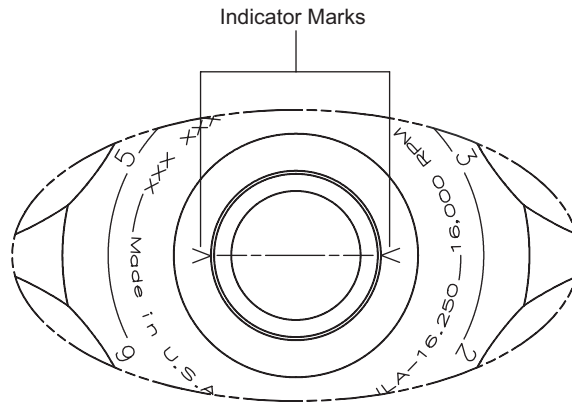

Figure 3. Rotor Top View: Indicator Marks Show Drive Pin Orientation

7. Secure the rotor to the centrifuge drive spindle as follows:

Dual-locking lid: press the lid knob down and turn it to the right (clockwise) until secure, no more than two full turns. Do not overtighten.

Single-locking lid: place filled tubes into the rotor, then place the lid on the rotor. Press the lid knob down and turn it to the right (clockwise) until secure. Do not overtighten.



WARNING

If the rotor is left in the centrifuge between runs, make sure that the rotor is seated on the drive hub and that the tie-down knob is tight before each run.

TEMPERATURE

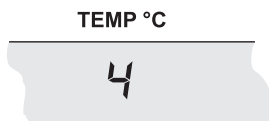

To ensure that the JLA-16.250 rotor reaches the required temperature during the run, follow the appropriate instructions below for the J centrifuge model being used.

Avanti J Series Centrifuges

Enter the run temperature according to the instructions in your centrifuge instruction manual. No additional input is required.

J2 Series Centrifuges

Enter the required run temperature and the appropriate temperature compensation units (see Tables 1 and 2) on the centrifuge control panel following the instructions below.

Table 1. Temperature Compensation Settings for Analog and Microprocessor-Controlled Centrifuges (Models J2-HS, J2-21, J2-MI, J2-21M, J2-MC, and J2-21M/E). Interpolate if intermediate values are required.

Rotor Speed (rpm)	Required Sample Temperature (°C)					
	-10	2	5	10	20	40
14 000	N	-7	-5	-4	-3	-3
10 000	-4	-3	-3	-2	-1	N
5 000	0	0	0	0	0	N

“N” indicates that the rotor cannot achieve the required temperature at this speed.

Table 2. Temperature Compensation Settings for the Model J2-HC Analog Centrifuge. Interpolate if intermediate values are required.

Rotor Speed (rpm)	Required Sample Temperature (°C)					
	-10	2	5	10	20	40
14 000	N	-7	-7	-7	-5	-4
10 000	-4	-3	-3	-2	-1	N
5 000	0	0	-3	-3	-3	N

“N” indicates that the rotor cannot achieve the required temperature at this speed.

Analog J2 Series Centrifuges (Models J2-HS, J2-21, and J2-HC)

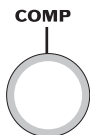

1. Turn the SET knob on the centrifuge control panel to the required sample temperature.
2. Find the compensation value in Table 1 or Table 2 that corresponds to the required temperature and run speed. Set the COMP dial to that setting. (Interpolate if intermediate values are required.)

Microprocessor-Controlled J2 Series Centrifuges (Models J2-MI, J2-21M, J2-MC, and J2-21M/E)

Enter rotor code 14, then follow the steps below.

1. Press the [TEMP] key on the centrifuge control panel and then use the keypad to enter the sample temperature.
2. Find the compensation value in Table 1 that corresponds with the set temperature and run speed.
3. Press [COMP ADJ]. The word “COMP” flashes below the TEMPERATURE display and the display flashes.
4. Use the keypad to enter the desired compensation value. Press the [±.] key to enter a minus sign; pressing it again will remove the minus sign.

TEMPERATURE °C

COMP

5. Check the temperature display. (If the entry is incorrect, press [CE] and reenter the digits.)
6. When the entry is correct, press [ENTER/RECALL].

 **NOTE**

To clear a COMP ADJ entry, press [COMP ADJ], [0], and [ENTER/RECALL].

RUN PROCEDURE



WARNING

Operator error or tube failure may generate aerosols. Toxic, pathogenic, or other hazardous materials must not be run in this rotor unless all appropriate safety precautions are taken. Also see the Safety Notice at the beginning of this manual.



CAUTION

Make sure that the rotor is properly seated on and securely fastened to the drive hub before each run.

When the rotor is properly loaded and installed in the centrifuge, you are ready to perform the run. Refer to the applicable centrifuge instruction manual for operating instructions.

 **NOTE**

Line voltage fluctuations can cause variations in acceleration and deceleration times.

REMOVAL AND SAMPLE RECOVERY



CAUTION

If disassembly reveals evidence of leakage, you should assume that some fluid escaped the rotor. Apply appropriate decontamination procedures to the centrifuge and accessories, as required.

Dual-Locking Lid



1. Place one hand on the rotor to keep it from turning. Grasp the tie-down knob with your other hand and turn it to the left (counterclockwise), while pulling up, until the stem disengages from the drive hub.
2. Place your hands on the rotor and lift the rotor straight up off the drive hub. *Do not lift the rotor by the tie-down knob.*
3. Place the rotor on a counter or bench top under a safety hood (if required).
4. Grasp the daisy knob and turn it to the left (counterclockwise) until it disengages.
5. Remove the lid and set it aside. If the lid cannot be removed, first pull up on the tie-down knob to release vacuum inside the rotor, and then remove the lid.



CAUTION

*Always loosen the round tie-down knob to disengage the rotor from the centrifuge drive hub **before** attempting to loosen the daisy knob. The dual-locking lid assembly can be damaged if the daisy knob is loosened while the rotor is still engaged with the hub.*



Single-Locking Lid

1. Unscrew the tie-down knob to release the rotor from the drive hub.
2. Remove the lid and set it aside.
3. Lift the rotor straight up off the drive hub. *Do not lift the rotor by the tie-down knob.*

NOTE

Lubricating the centrifuge drive hub with Spinkote should prevent the rotor from sticking in J2 series centrifuges. In Avanti J series centrifuges, the drive hubs do not need lubrication because Delrin rings on the hubs prevent sticking.

BOTTLES AND TUBES

The JLA-16.250 rotor uses the bottles and tubes listed in Table 3. Be sure to use only those items listed and observe the maximum fill volumes and speed limits shown. (Maximum fill volume is the maximum amount of fluid that can be centrifuged in the listed container.) To minimize the possibility of leakage from capped tubes or bottles, load tubes or bottles with sample, secure the caps, and precool the loaded, sealed labware to run temperature before beginning the run.

Refer to Appendix A in *Rotors and Tubes* for information on the chemical resistances of tube and accessory materials.

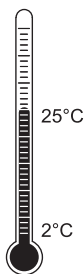

Temperature Limits

- Plastic containers have been tested for use at temperatures between 2 and 25°C. For centrifugation at other temperatures, pretest containers under anticipated run conditions.
- If plastic containers are frozen before use, make sure that they are thawed to at least 2°C before centrifugation.

Table 3. Available Bottles and Tubes for the JLA-16.250 Rotor.
Use only the items listed here and observe fill volumes and maximum run speeds.

Dimensions and Volume	Tube Description	Part Number	Max. Fill Volume (mL)	Required Accessory			Max Speed ^a / RCF/ k Factor
				Description	Part Number	Tubes per Adapter	
62 × 120 mm 250 mL	polypropylene bottle w/cap assembly	356011	250	none			16 000 rpm 38 500 × g 1 070
62 × 120 mm 250 mL	polycarbonate bottle w/cap assembly	356013	250	none			16 000 rpm 38 500 × g 1 090
29 × 104 mm 50 mL	polyallomer bottle w/cap assembly	357001	40	adapter	356997 ^b	1	16 000 rpm 32 200 × g 650
29 × 104 mm 50 mL	polycarbonate bottle w/cap assembly	357000	40	adapter	356997	1	16 000 rpm 32 400 × g 660
29 × 104 mm 50 mL	polycarbonate bottle, screw-on cap	357002	38.5	adapter	356997	1	16 000 rpm 32 200 × g 660
29 × 104 mm 50 mL	polyallomer bottle, screw-on cap	357003	38.5	adapter	356997	1	16 000 rpm 32 200 × g 650
29 × 104 mm 50 mL	thickwall polycarbonate, snap-on cap	363664	36	adapter	356997	1	16 000 rpm 32 100 × g 400
29 × 104 mm 50 mL	thickwall polypropylene, snap-on cap	357005	36	adapter	356997	1	16 000 rpm 32 100 × g 400
17 × 119 mm 15 mL	conical tube	^c	15	adapter	356964 ^b	4	^c
Bio-vials 4 mL	polypropylene	566353	4	adapter	342098 ^d	9	4 000 rpm 2 300 × g 10 700

^a Maximum speeds listed are guidelines only. These speeds have been achieved in reliability tests at Beckman Coulter, but because of manufacturing variances no guarantee of performance or fit is expressed or implied. (The maximum rotor speed in J2 series centrifuges is 14 000 rpm.)

^b Polypropylene.

^c Commercially available. Observe manufacturer's maximum speed and fill guidelines.

^d Delrin. Delrin is a registered trademark of E.I. DuPont de Nemours & Company.



Thickwall Tubes

Thickwall polyallomer, polypropylene, and polycarbonate tubes can be run partially filled (at least half filled) with or without caps, but all opposing tubes for a run must be filled to the same level with liquid of the same density. Do not overfill capless tubes; be sure to note the fill volumes and run speeds shown in Table 3.



Polycarbonate and Polyallomer Bottles

Capped polycarbonate and polyallomer bottles may be centrifuged completely or partially filled (not less than half full). Again, all opposing containers for a run must be filled to the same level.

RUN TIMES



The k factor is a measure of a rotor's pelleting efficiency. Beckman Coulter has calculated the k factor for all of its rotors, at maximum speed with full bottles or tubes, using the following formula:

$$k = \frac{\ln(r_{\max}/r_{\min})}{\omega^2} \times \frac{10^{13}}{3600} \quad (1)$$

Where ω is the angular velocity of the rotor in radians per second ($\omega = 0.105 \times \text{rpm}$), r_{\max} is the maximum radius, and r_{\min} is the minimum radius.

After substitution:

$$k = \frac{(2.533 \times 10^{11}) \ln(r_{\max}/r_{\min})}{\text{rpm}^2} \quad (2)$$

Use the k factor in the following equation to estimate the run time t (in hours) required to pellet particles of known sedimentation coefficient s (in Svedberg units, S).

$$t = \frac{k}{s} \quad (3)$$

For centrifugation below maximum speed, estimate the run time required by adjusting the k factor as follows:

$$k_{\text{adj}} = k \left(\frac{\text{maximum speed}}{\text{actual run speed}} \right)^2 \quad (4)$$

Run times can also be estimated from data established in prior experiments using a different rotor if the k factor of the previous rotor is known. For any two rotors, a and b:

$$\frac{t_a}{t_b} = \frac{k_a}{k_b} \quad (5)$$

Where the k factors have been adjusted for the actual run speed used.

For more information on k factors, see *Use of k Factor for Estimating Run Times from Previously Established Run Conditions* (publication DS-719).

RUN SPEEDS

SPEED



16 000 RPM

The centrifugal force at a given radius in a rotor is a function of run speed. Comparisons of forces between different rotors are made by comparing the rotors' relative centrifugal fields (RCF). When rotational speed is adjusted so that identical samples are subjected to the same RCF in two different rotors, the samples are subjected to the same force. The RCF at a number of rotor speeds is provided in Table 4.

Table 4. Relative Centrifugal Fields for the JLA-16.250 Rotor.

Entries in this table are calculated from the formula

$$RCF = 1.12r (RPM/1000)^2$$

and are then rounded to three significant digits.

Rotor Speed (rpm)	Relative Centrifugal Field ($\times g$)		
	at r_{\max} (134 mm)	at r_{av} (90 mm)	at r_{\min} (46 mm)
16 000	38 400	25 800	13 200
15 000	33 800	22 700	11 600
14 000	29 400	19 800	10 100
13 000	25 400	17 000	8 710
12 000	21 600	14 500	7 420
11 000	18 200	12 200	6 230
10 000	15 000	10 100	5 150
9 000	12 200	8 160	4 170
8 000	9 610	6 450	3 300
7 000	7 350	4 940	2 520
6 000	5 400	3 630	1 860
5 000	3 750	2 520	1 290
4 000	2 400	1 610	824
3 000	1 350	907	464
2 000	600	403	206
1 000	150	100	52
500	38	25	13

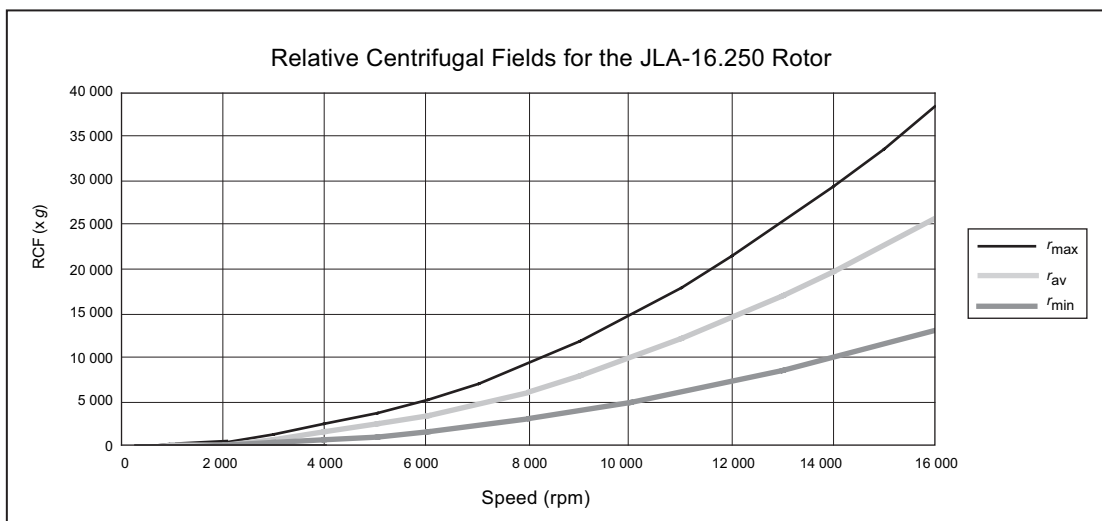

Do not select rotational speeds higher than the maximums you have determined to be appropriate for your protocols (in no case above 16 000 rpm in an Avanti J series centrifuge or 14 000 rpm in a J2 series centrifuge, or above the limit shown in Table 3). When solutions more dense than 1.2 g/mL are centrifuged in this rotor, use equation (6) to calculate the reduced maximum allowable speed in Avanti J series centrifuges. Use equation (7) to calculate the reduced maximum allowable speed in J2 series centrifuges.

$$\text{reduced maximum speed} = (16\,000 \text{ rpm}) \sqrt{\frac{1.2 \text{ g/mL}}{\text{density of tube contents}}} \quad (6)$$

$$\text{reduced maximum speed} = (14\,000 \text{ rpm}) \sqrt{\frac{1.2 \text{ g/mL}}{\text{density of tube contents}}} \quad (7)$$

Note, however, that the use of this formula may still produce maximum speed figures higher than the limitations imposed by the use of certain tubes or adapters (see Table 3). In such cases, use the lower of the two figures.

CARE AND MAINTENANCE

INSPECTION

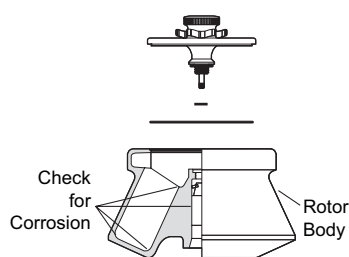

Periodically (at least monthly) inspect the rotor body for rough spots or pitting, white powder deposits—frequently aluminum oxide—or heavy discoloration. If any of these signs are evident, do not use the rotor. Contact your Beckman Coulter representative for information about the Field Rotor Inspection Program (FRIP) and the rotor repair center.

Before using the rotor, inspect the rotor drive pins to ensure that they are not damaged. Damaged drive pins can prevent the rotor from seating properly on the centrifuge drive hub (Avanti J series centrifuges only). To inspect the drive pins, turn the rotor upside down and look into the drive hole in the center of the rotor. If the drive pins appear damaged, contact Beckman Coulter Field Service.

MAINTENANCE

- Regularly apply silicone vacuum grease to the large and small O-rings. Replace the O-rings about twice a year, or whenever worn or damaged.
- Routinely apply a light coat of Spinkote lubricant to the centrifuge drive hub (J2 series centrifuges only) and to the rotor drive hole to prevent the rotor from sticking. Lubricate the lid knob threads before each use.
- Do not use sharp tools on the rotor, as they can scratch the anodized surface. Corrosion begins in scratches and may open fissures in the metal with continued use.
- Do not store the rotor with the lid tightened. The constant compression on the O-rings caused by a tightened lid may reduce O-ring life.

Refer to Appendix A in *Rotors and Tubes* for the chemical resistances of rotor and tube materials. Your Beckman Coulter representative provides contact with the Field Rotor Inspection Program and the rotor repair center.

CLEANING



Wash the rotor and rotor components immediately if salts or other corrosive materials are used or if spillage has occurred. Do not allow corrosive materials to dry on the rotor.

Under normal use, wash the rotor frequently (at least weekly) to prevent buildup of residues. If the rotor is left in the centrifuge for long periods of time, remove the rotor from the centrifuge at least once a month for cleaning and lubrication.

1. Remove the O-rings from the rotor lid before cleaning. (To avoid scratching the rotor or damaging the O-rings, remove the O-rings using a toothpick or other non-metal tool.)
2. Wash the rotor, lid, and O-rings using a mild detergent, such as Beckman Solution 555™ (339555). The Rotor Cleaning Kit (339558) contains two brushes and two quarts of Solution 555 for use with rotors and accessories. Dilute the detergent 10 to 1 with water.

NOTE

Do not wash the rotor components or accessories in a dishwasher. Do not soak components in detergent solution for long periods of time, such as overnight.

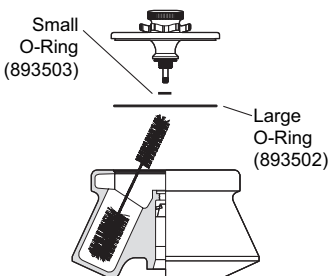

3. Thoroughly rinse the cleaned rotor and components with distilled water.
4. Air-dry the rotor and lid upside down. *Do not use acetone to dry the rotor.*
5. Apply a thin, even coat of silicone vacuum grease to the lid O-rings and replace them in the grooves in the lid. Be careful not to stretch, roll, or twist the O-rings during installation.

Clean metal threads every 6 months, or as necessary. Use a brush and concentrated Solution 555. Rinse and dry thoroughly, then lubricate lightly but evenly with Spinkote to coat all threads.

Periodically remove the O-rings and wipe clean as necessary. Clean the O-ring grooves with a cotton-tipped swab. Reapply a light film of silicone vacuum grease.

DECONTAMINATION

If the rotor (and/or accessories) becomes contaminated with radioactive material, decontaminate it using a solution that will not damage the anodized surfaces. Beckman Coulter has tested a number of solutions and found several that do not harm anodized aluminum: RadCon Surface Spray or IsoClean Solution (for soaking),² and Radiacwash.³

NOTE

IsoClean can cause fading of colored anodized surfaces, such as the blue rotor lid. Use it only when necessary and remove it promptly from rotor surfaces.

² In U.S.A., contact Nuclear Associates (New York); in Eastern Europe and Commonwealth States, contact Victoreen GmbH (Munich); in South Pacific, contact Gammasonics Pty, Ltd. (Australia); in Japan, contact Toyo Medic Co. Ltd. (Tokyo).

³ In U.S.A., contact Biodex Medical Systems (Shirley, NY); internationally, contact the U.S. office to find the dealer nearest you.

While Beckman Coulter has tested these methods and found that they do not damage the rotor or components, no guarantee of sterility or disinfection is expressed or implied. When sterilization or disinfection is a concern, consult your laboratory safety officer regarding proper methods to use.



If the rotor or other components are contaminated with toxic or pathogenic materials, follow appropriate decontamination procedures as outlined by your laboratory safety officer. Refer to *Rotors and Tubes* to evaluate your rotor's ability to withstand a given chemical solution.

STERILIZATION AND DISINFECTION

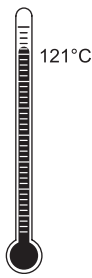

- The rotor and all rotor components can be autoclaved at 121°C for up to one hour. Place the rotor in the autoclave upside down, with the lid removed.
- Ethanol (70%)⁴ or hydrogen peroxide (6%) may be used on all rotor components, including those made of plastic. Bleach (sodium hypochlorite) may be used, but may cause discoloration of anodized surfaces. Use the minimum immersion time for each solution, per laboratory standards.

While Beckman Coulter has tested these methods and found that they do not damage components, no guarantee of sterility or disinfection is expressed or implied. When sterilization or disinfection is a concern, consult your laboratory safety officer regarding proper methods to use.

Refer to publication IN-192, included in each box of tubes or bottles, for tube and bottle sterilization and disinfection procedures.

TUBE BREAKAGE

If a glass bottle or tube breaks, remove the glass very carefully from the rotor and/or adapter. Imbedded glass particles that remain in the rotor cavities or adapters can cause tube failure during subsequent runs. Clean the rotor thoroughly *immediately* following a bottle or tube breakage.

⁴ Flammability hazard. Do not use in or near operating centrifuges.

STORAGE

When the rotor is not in use, store it in a dry environment (not in the centrifuge) with the lid removed to allow air circulation so moisture will not collect in the tube cavities.

RETURNING A ROTOR

Before returning a rotor or accessory for any reason, prior permission (a Returned Goods Authorization form) must be obtained from Beckman Coulter, Inc. This RGA form, which may be obtained from your local Beckman Coulter sales office, should contain the following information:

- rotor serial number,
- history of use (approximate frequency of use),
- reason for the return,
- original purchase order number, billing number, and shipping number, if possible,
- name and phone number of the person to be notified upon receipt of the rotor or accessory at the factory, and
- name and phone number of the person to be notified about repair costs, etc.

To protect our personnel, it is the customer's responsibility to ensure that the parts are free from pathogens and/or radioactivity. Sterilization and decontamination must be done before returning the parts. Smaller items (such as tubes, bottles, etc.) should be enclosed in a sealed plastic bag.

*All parts must be accompanied by a note, plainly visible on the outside of the box or bag, stating that they are safe to handle and that they are not contaminated with pathogens or radioactivity. **Failure to attach this notification will result in return or disposal of the items without review of the reported problem.***

Use the address label printed on the RGA form when mailing the rotor and/or accessories.

Customers located outside the United States should contact their local Beckman Coulter office.

SUPPLY LIST

Call Beckman Coulter Sales (1-800-742-2345 in the United States) or your local Beckman Coulter office, or see the *Beckman Coulter High Performance, High Speed, High Capacity Rotors, Tubes & Accessories* catalog (BR-8102, available at www.beckmancoulter.com) for detailed information on ordering parts and supplies. For your convenience, a partial list is given below.

NOTE

Publications referenced in this document can be obtained by calling Beckman Coulter at 1-800-742-2345 in the United States, or by contacting your local Beckman Coulter office.

REPLACEMENT ROTOR PARTS

JLA-16.250 rotor assembly, biosafe (with dual-locking lid)	363930
JLA-16.250 rotor assembly (with single-locking lid)	363934
Dual-locking lid assembly	363931
Single-locking lid assembly	363935
Large lid O-ring (qty/2)	893502
Small lid O-ring (qty/2)	893503

SUPPLIES

Bottles, tubes, and adapters	see Table 3
Rotor Cleaning Kit	339558
Silicone vacuum grease (1 oz)	335148
Solution 555 (1 qt)	339555
Spinkote lubricant (2 oz)	306812

J SERIES ROTOR WARRANTY

Subject to the conditions specified below and the warranty clause of the Beckman Coulter, Inc., terms and conditions of sale in effect at the time of sale, Beckman Coulter, Inc. agrees to correct either by repair, or, at its election, by replacement, any defects of material or workmanship which develop within seven (7) years after delivery of a J series rotor to the original buyer by Beckman Coulter, Inc. or by an authorized representative, provided that investigation and factory inspection by Beckman Coulter, Inc. discloses that such defect developed under normal and proper use. Should a Beckman Coulter centrifuge be damaged due to a failure of a rotor covered by this warranty, Beckman Coulter will supply free of charge all centrifuge parts required for repair.

REPLACEMENT

Any product claimed to be defective must, if requested by Beckman Coulter, Inc., be returned to the factory, transportation charges prepaid, and will be returned to Buyer with the transportation charges collect unless the product is found to be defective, in which case Beckman Coulter, Inc. will pay all transportation charges.

A defective rotor will be replaced by Beckman Coulter, Inc. at its then current list price less a credit based upon the age of the rotor (years since date of purchase). The Buyer shall not receive credit until the claimed defective rotor is returned to Beckman Coulter's Indianapolis, Indiana facility or delivered to a Beckman Field Service representative.

The replacement price (cost to Buyer) for the respective rotor shall be calculated as follows:

$$\text{Replacement price} = \text{Current rotor list price} \times \frac{\text{years}}{7}$$

CONDITIONS

1. Except as otherwise specifically provided herein, this warranty covers the rotor only and Beckman Coulter, Inc. shall not be liable for damage to accessories or ancillary supplies including but not limited to (i) tubes, (ii) tube caps, (iii) tube adapters, or (iv) tube contents.
2. This warranty is void if the rotor has been subjected to customer misuse such as operation or maintenance contrary to the instructions in the Beckman Coulter rotor or centrifuge manual.
3. This warranty is void if the rotor is operated with a rotor drive unit or in a centrifuge unmatched to the rotor characteristics, or is operated in a Beckman Coulter centrifuge that has been improperly disassembled, repaired, or modified.

DISCLAIMER

IT IS EXPRESSLY AGREED THAT THE ABOVE WARRANTY SHALL BE IN LIEU OF ALL WARRANTIES OF FITNESS AND OF THE WARRANTY OF MERCHANTABILITY AND THAT BECKMAN COULTER, INC. SHALL HAVE NO LIABILITY FOR SPECIAL OR CONSEQUENTIAL DAMAGES OF ANY KIND WHATSOEVER ARISING OUT OF THE MANUFACTURE, USE, SALE, HANDLING, REPAIR, MAINTENANCE, OR REPLACEMENT OF THE PRODUCT.



Beckman Coulter, Inc. • 250 S. Kraemer Blvd. • Brea, California 92821
Sales and Service: 1-800-742-2345 • Internet: www.beckmancoulter.com

©2009 Beckman Coulter, Inc.
All rights reserved